

UPS JBUS/MODBUS 适配卡 用户手册

资料版本: V1.5
归档时间: 2010-12-14
BOM 编号: 31011134

艾默生网络能源有限公司为客户提供全方位的技术支持, 用户可与就近的艾默生网络能源有限公司办事处或客户服务中心联系, 也可直接与公司总部联系。

艾默生网络能源有限公司
版权所有, 保留一切权利。内容如有改动, 恕不另行通知。

艾默生网络能源有限公司
地址: 深圳市南山区科技工业园科发路一号
邮编: 518057
公司网址:
www.emersonnetworkpower.com.cn
客户服务热线: 4008876510
E-mail: service@emersonnetwork.com.cn

UPS JBUS/MODBUS Adapter User Manual

Version: V1.5
Revision date: December 14, 2010
BOM: 31011134

Emerson Network Power provides customers with technical support. Users may contact the nearest Emerson local sales office or service center.

Copyright © 2005 by Emerson Network Power Co., Ltd.

All rights reserved. The contents in this document are subject to change without notice.

Emerson Network Power Co., Ltd.
Address: No.1 Kefa Rd., Science & Industry Park,
Nanshan District 518057, Shenzhen China
Homepage: www.emersonnetworkpower.com.cn
E-mail: support@emersonnetwork.com.cn

目 录

第一章 产品介绍	1
1.1 简介	1
1.2 技术指标与特点	1
1.3 外观和硬件说明	1
第二章 安装	3
2.1 开箱验货	3
2.2 安装注意事项	3
2.3 安装步骤	3
2.3.1 设置适配卡基本参数	3
2.3.2 将适配卡插入 UPS 或 FLP	5
2.3.3 连接通讯电缆	5
2.3.4 设置后台软件通讯参数	6
第三章 协议文本	7
3.1 UL33 UPS 协议文本	7
3.2 UH31 UPS 协议文本	10
3.3 UH11 UPS 协议文本	12
3.4 iTrust 2G UPS 协议文本	13
3.5 iTrust Adapt 5/10kVA UPS 协议文本	15
3.6 NXa/NXb/NXe UPS 协议文本	16
3.7 Hipulse U UPS 和 FLP 协议文本	20
3.8 NXr 和 iTrust Adapt 16/20kVA UPS 协议文本	23
3.9 APM 150 UPS 协议文本	27
第四章 常见问题及解决方法	34
附录一 有毒有害物质或元素标识表	35

第一章 产品介绍

1.1 简介

UPS JBUS/MODBUS 适配卡（下文简称“适配卡”）使您可以通过用户后台监控软件采用 JBUS/MODBUS（RTU）协议来管理您的艾默生 UPS 和 FLP 场馆照明专用电源系统（简称“FLP”）设备，通过获取设备的各种电气参数、运行状态和故障类别来掌握设备工作状态。

适配卡目前所支持的 UPS 和 FLP 设备详见表 1-1。

表1-1 适配卡所支持 UPS 和 FLP 设备

序号	设备	设备系列
1	UL33 UPS	iTrust 系列
2	UH31 UPS	
3	UH11 UPS	
4	iTrust 2G UPS	
5	iTrust Adapt UPS 5/10/16/20kVA	
6	NXa UPS	NX 系列
7	NXb UPS	
8	NXe UPS	
9	Hipulse U UPS 120/160/200/300/400 kVA	Hipulse U 系列
10	FLP120/160/200/300/400 kVA	FLP 系列
11	NXr UPS	NXr 系列
12	APM 150 UPS	

1.2 技术指标与特点

- 采用协议种类：JBUS/MODBUS（RTU）协议；
- 支持通讯方式：支持 RS485 和 RS232 通讯方式；
- 物理地址设置范围：1~31；
- 通讯波特率设置范围：2400、4800、9600（默认）、19200bps；
- 通讯数据格式：1 位起始位，8 位数据，1 位停止位，无奇偶校验位；
- CRC16 的标准校验方式，先高字节，后低字节；
- 支持热插拔，安装方便。

1.3 外观和硬件说明

外观图

适配卡为内置式插卡结构，安装于 UPS 和 FLP 的 SNMP 卡插槽，其外观如图 1-1。



图1-1 适配卡外观图

硬件说明

适配卡的印制板有两个尺寸：130mm（长）×60mm（宽）×1.6mm（高）和 130mm（长）×63mm（宽）×1.6mm（高），且前者的插口开有一道槽。前者适用于 NX、NXr 系列 UPS、iTrust Adapt UPS 和 APM 150 UPS，后者适用于 Hipulse U 系列 UPS、FLP、以及除 iTrust Adapt 以外的其它 iTrust 系列 UPS 产品。

如图 1-1 所示，适配卡提供通讯接口、设备通讯状态指示灯、主机通讯状态指示灯、适配卡插口和拨码开关，其功能说明见表 1-2。

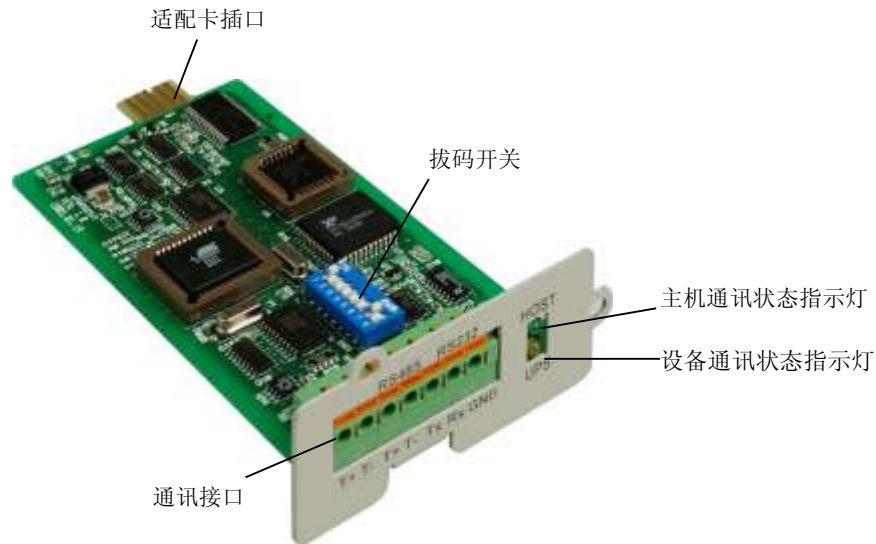
表1-2 硬件功能说明表

名称	说明
通讯接口	与后台监控计算机的通讯接口，支持 RS232 和 RS485 两种通讯方式
设备通讯状态指示灯（黄色）	常灭：无电源输入
	常亮：有电源输入，但未与 UPS 或 FLP 通讯
	慢速闪烁（5 秒闪烁一次）：与 UPS 或 FLP 通讯异常
	快速闪烁（约 1 秒闪烁一次）：与 UPS 或 FLP 通讯正常
主机通讯状态灯（绿色）	常灭：没有连接上后台监控主机
	闪烁：与后台监控主机通讯正常
适配卡插口	插入 UPS 或 FLP 的 SNMP 卡插槽，与 UPS 或 FLP 相连
拨码开关	用于设置适配卡的基本参数

警告

本适配卡的各个外接端口必须连接安全超低电压（SELV）电路，否则可能会损坏本适配卡。

第二章 安装

2.1 开箱验货

货到后，请打开适配卡包装，取出发货清单（见表 2-1），与实物核对检查。如有不符，请立即与经销商联系。

表2-1 适配卡发货清单

序号	货物名称	数量	备注
1	适配卡	1 块	
2	光盘	1 张	适配卡用户手册

2.2 安装注意事项

1. 适配卡安装于 UPS 或 FLP 的 SNMP 卡插槽，该插槽为适配卡和 SNMP 卡共用插槽。因此，如果您使用适配卡将不能同时使用 SNMP 卡。
2. 适配卡有两种尺寸，请检查您持有的适配卡是否与 UPS 或 FLP 相匹配（参见第 1.3 节的硬件说明）。否则，将不能插入 UPS 或 FLP 后的 SNMP 卡插槽。
3. 适配卡中的某些电子器件对静电十分敏感，请勿用手或其它带电物体接触适配卡上的电子器件或电路，以防静电击坏适配卡。移动或安装适配卡时必须抓住卡的侧面边缘进行操作。

2.3 安装步骤

请按以下顺序进行适配卡的安装：

1. 设置适配卡基本参数；
2. 将适配卡插入 SNMP 卡插槽；
3. 连接通讯电缆；
4. 设置后台软件通讯参数。

2.3.1 设置适配卡基本参数

要正常实现适配卡的功能，必须对其基本参数进行正确设置。

须设置的基本参数包括：

- 物理地址；
- 通讯波特率。

适配卡基本参数的设置是通过适配卡上的拨码开关（位置参见图 1-1）实现的。该拨码开关共有 8 位，拨上为 ON，拨下为 OFF，如下图。



图2-1 拨码开关

适配卡基本参数的设置由该拨码开关的第 1 位到第 7 位完成，第 8 位为厂家预留。图中所示拨码开关位置为厂家默认设置。

设置物理地址

适配卡的物理地址设置由拨码开关的第 1 到第 5 位完成，设置范围为 1~31，0 为厂家保留设置，出厂默认设置为 1。

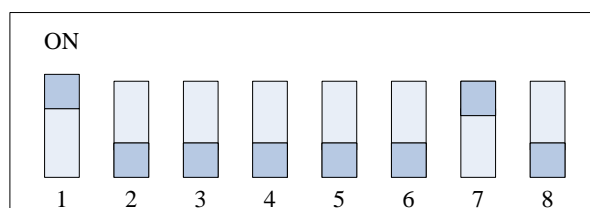
物理地址具体设置方法如下表所示：

表2-2 物理地址设置方法

物理地址	位 1	位 2	位 3	位 4	位 5
0	OFF	OFF	OFF	OFF	OFF
1	ON	OFF	OFF	OFF	OFF
2	OFF	ON	OFF	OFF	OFF
3	ON	ON	OFF	OFF	OFF
4	OFF	OFF	ON	OFF	OFF
5	ON	OFF	ON	OFF	OFF
6	OFF	ON	ON	OFF	OFF
7	ON	ON	ON	OFF	OFF
8	OFF	OFF	OFF	ON	OFF
9	ON	OFF	OFF	ON	OFF
10	OFF	ON	OFF	ON	OFF
11	ON	ON	OFF	ON	OFF
12	OFF	OFF	ON	ON	OFF
13	ON	OFF	ON	ON	OFF
14	OFF	ON	ON	ON	OFF
15	ON	ON	ON	ON	OFF
16	OFF	OFF	OFF	OFF	ON
17	ON	OFF	OFF	OFF	ON
18	OFF	ON	OFF	OFF	ON
19	ON	ON	OFF	OFF	ON
20	OFF	OFF	ON	OFF	ON
21	ON	OFF	ON	OFF	ON
22	OFF	ON	ON	OFF	ON
23	ON	ON	ON	OFF	ON
24	OFF	OFF	OFF	ON	ON
25	ON	OFF	OFF	ON	ON
26	OFF	ON	OFF	ON	ON
27	ON	ON	OFF	ON	ON
28	OFF	OFF	ON	ON	ON
29	ON	OFF	ON	ON	ON
30	OFF	ON	ON	ON	ON
31	ON	ON	ON	ON	ON

警告

适配卡物理地址 0 为厂家保留地址，用户不可设置为该地址，否则适配卡将不能正常工作。

设置通讯波特率

适配卡的通讯波特率设置由拨码开关的第 6 位和第 7 位完成。设置范围为 2400bps、4800bps、9600bps、19200bps，默认设置为 9600bps。

通讯波特率具体设置方法如下表所示：

表2-3 通讯波特率设置方法

通讯波特率 (bps)	位 6	位 7
2400	OFF	OFF
4800	ON	OFF
9600	OFF	ON
19200	ON	ON

2.3.2 将适配卡插入 UPS 或 FLP

提示

适配卡支持热插拔，在安装时不必关闭 UPS 或 FLP 电源。

请按以下步骤将适配卡插入 UPS 或 FLP 后的 SNMP 卡插槽：

1. 取下 UPS 或 FLP 后面 SNMP 卡插槽的盖板。

请妥善保留螺钉和盖板，以备将来使用。SNMP 卡插槽在 UPS 或 FLP 上的具体位置参见相应 UPS 和 FLP 用户手册。

2. 将适配卡插口对准 SNMP 卡插槽，顺着插槽两侧的导槽插入，使用螺钉通过适配卡面板上的固定孔将适配卡固定。

十几秒钟后，您将会看到适配卡面板上的黄色设备通讯状态指示灯快速闪烁，说明适配卡已经开始运行并与 UPS 或 FLP 建立正常通讯。

2.3.3 连接通讯电缆

将适配卡插入 UPS 或 FLP 的 SNMP 卡插槽并固定后，即可进行适配卡通讯接口与后台监控计算机的 RS232 串口之间的通讯电缆连接。

适配卡通讯接口说明

适配卡的通讯接口如图 2-2。



图2-2 通讯接口

如图所示，左边四个端子用于 RS485 通讯连接，右边三个端子用于 RS232 通讯连接。各端子定义见表 2-4。

表2-4 通讯接口端子说明

端子名称	说明
T+	RS485 通讯差分信号+，2 个，内部短接，用于级联。
T-	RS485 通讯差分信号-，2 个，内部短接，用于级联。
Tx	RS232 通讯信号发送端
Rx	RS232 通讯信号接收端
GND	信号地

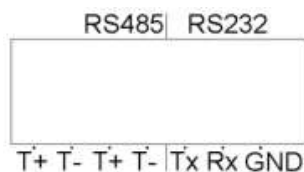
连接通讯电缆

适配卡与后台监控计算机之间可有以下两种通讯连接方式。

1. RS232 通讯方式

适配卡与计算机 RS232 串口相连时，请按下表所示对应关系进行通讯电缆连接。

表2-5 适配卡通讯接口与计算机串口的连接方法（RS232 方式）

适配卡通讯接口	计算机 RS232 串口（DB9 公头）
Tx	第 2 脚
Rx	第 3 脚
GND	第 5 脚

2. RS485 通讯方式

采用 RS485 通信方式连接适配卡与计算机串口时，需要自备一个 RS232/RS485 转换器，按下表所示对应关系进行通讯电缆连接。RS232/RS485 转换器的通讯接口定义参见其产品手册。

表2-6 适配卡通讯接口与 RS232/485 协议转换器接口的连接方法（RS485 方式）

适配卡通讯接口	RS232/RS485 转换器的 RS485 接口
T+	RS485 通讯差分信号+
T-	RS485 通讯差分信号-

表2-7 RS232/485 协议转换器接口与计算机串口的连接方法（RS485 方式）

RS232/RS485 转换器的 RS232 接口	计算机 RS232 串口（DB9 公头）
RS232 数据发送端	第 2 脚
RS232 数据接收端	第 3 脚
信号地	第 5 脚



警告

RS232 和 RS485 通讯方式不能够同时使用。

2.3.4 设置后台软件通讯参数

完成通讯电缆连接后，请启动用户后台监控软件，进行通讯参数设置。注意后台监控软件的通讯参数设置必须与适配卡拨码开关的物理地址和通讯波特率设置完全一致。具体设置方法参见用户后台监控软件的用户手册。

完成软件通讯参数设置后，您将会看到适配卡的绿色主机通讯状态指示灯也将闪烁，这表明适配卡已开始正常运行并建立与用户后台监控软件的通讯。观察监控软件，您将看到 UPS 或 FLP 各项数据的显示。

至此，您已成功完成适配卡的安装。

第三章 协议文本

通过后台监控软件对带有适配卡的 UPS 或 FLP 进行监控，需要该软件支持 JBUS/MODBUS (RTU) 通讯协议，并对所监控的 UPS 或 FLP 相对应的 JBUS/MODBUS (RTU) 协议文本进行解析。

注意

1. 适配卡只对后台监控软件提供对功能码为#03 的查询命令的应答信息，对于其它功能码将不作任何应答。
2. 适配卡对后台监控软件提供功能码为#03 的查询命令的应答信息时，如果要求的查询字节数大于 100，将返回无效数据地址信息，异常代码为 # 02。
3. 使用 JBUS/MODBUS (RTU) 协议时，适配卡扮演通讯从机角色，等待后台监控计算机来查询。

下面各节提供各类 UPS 或 FLP 的 JBUS/MODBUS (RTU) 协议文本。

3.1 UL33 UPS 协议文本

使用这个协议

1. 产品基本信息

ID	字节数	项目	值
1000~1004	10	UPS 名称	"UL33 0200L"
1005	2	厂家软件版本	0x010B 对应 V1.11
1006~1015	20	厂家名称	"EmersonNetworkPower"
1019	2	适配卡软件版本	0x010B 对应 V1.11

2. UPS 告警量

ID	位	项目	值
1030	Bit 0	UPS 告警标志位	0: 正常; 1: 告警
	Bit 1	适配卡通讯故障位	0: 正常; 1: 故障
	Bit 2	未定义	
	Bit 3	同步/不同步	0: 正常; 1: 不同步
	Bits 5/4	市电电压	00: 正常; 01: 异常; 10: 欠压
	Bit 6	整流器	0: 正常; 1: 故障
	Bit 7	逆变器	0: 正常; 1: 故障
	Bits 9/8	旁路情况 (电压或频率)	00: 正常 01: 超出跟踪范围 10: 超出保护范围
1031	Bits 12~10	蓄电池总电压状态	000: 正常 001: 电池无 010: 低于下限 (关机点) 011: 高于上限 (电压过高) 100: 接反 101: 预告警
	Bits 15~13	未定义	
	Bit 0	电池自检结果	0: 正常; 1: 需要更换
	Bit 1	市电频率	0: 正常; 1: 异常
	Bit 2	输入变压器过温	0: 正常; 1: 过温
	Bit 3	输出变压器过温	0: 正常; 1: 过温
	Bit 4	逆变晶闸管坏	0: 正常; 1: 异常
	Bit 5	旁路晶闸管坏	0: 正常; 1: 异常
Bit 6	用户操作故障	0: 正常; 1: 异常	
Bit 7	逆变散热器过温	0: 正常; 1: 过温	

ID	位	项目	值
1031	Bit 8	整流散热器过温	0: 正常; 1: 过温
	Bit 9	逆变风扇故障	0: 正常; 1: 故障
	Bit 10	整流风扇故障	0: 正常; 1: 故障
	Bit 11	电池接触器故障	0: 正常; 1: 异常
	Bit 12	主路接触器异常	0: 正常; 1: 异常
	Bit 13	辅助接触器异常	0: 正常; 1: 异常
	Bit 14	输入熔断器坏	0: 正常; 1: 异常
	Bit 15	输出熔断器坏	0: 正常; 1: 异常
1032	Bit 0	本机输出过载	0: 正常; 1: 过载
	Bit 1	并机系统过载	0: 正常; 1: 过载
	Bit 2	本机过载超时	0: 正常; 1: 过载超时
	Bit 3	旁路过流超时	0: 正常; 1: 过流超时
	Bit 4	辅作电源一故障	0: 正常; 1: 故障
	Bit 5	辅作电源二故障	0: 正常; 1: 故障
	Bit 6	旁路异常关机	0: 正常; 1: 故障
	Bit 7	旁路输入反序	0: 正常; 1: 故障
	Bit 8	主路输入反序	0: 正常; 1: 故障
	Bit 9	输入软启动失败	0: 正常; 1: 故障
	Bit 10	交流输出过压	0: 正常; 1: 故障
	Bit 11	输出冲击过流	0: 正常; 1: 故障
	Bit 12	逆变模块过流	0: 正常; 1: 故障
	Bit 13	整流模块过流	0: 正常; 1: 故障
	Bits 15/14	未定义	
1033	Bit 0	负载冲击转旁路	0: 正常; 1: 故障
	Bit 1	本小时允许切换次数限制	0: 正常; 1: 故障
	Bit 2	并机均流故障	0: 正常; 1: 故障
	Bit 3	母线电压低关机	0: 正常; 1: 故障
	Bit 4	邻机请求转旁路	0: 正常; 1: 故障
	Bit 5	环境温度过高	0: 正常; 1: 故障
	Bit 6	环境告警量通道 1 报警	0: 正常; 1: 故障
	Bit 7	环境告警量通道 2 报警	0: 正常; 1: 故障
	Bit 8	环境告警量通道 3 报警	0: 正常; 1: 故障
	Bit 9	环境告警量通道 4 报警	0: 正常; 1: 故障
	Bit 10	环境告警量通道 5 报警	0: 正常; 1: 故障
	Bit 11	环境告警量通道 6 报警	0: 正常; 1: 故障
	Bit 12	环境告警量通道 7 报警	0: 正常; 1: 故障
	Bit 13	环境告警量通道 8 报警	0: 正常; 1: 故障
	Bit 14	整流通讯故障	0: 正常; 1: 故障
	Bit 15	逆变通讯故障	0: 正常; 1: 故障
1034	Bit 0	并机板故障	0: 正常; 1: 故障
	Bit 1	直流母线过压故障	0: 正常; 1: 故障
	Bits 15~2	未定义	

3. UPS 状态量

ID	位	项目	值
1040	Bits 2/1/0	供电方式	000: 整流电池均不供电 001: 主路逆变供电 010: 电池逆变供电 011: 旁路供电 100: 联合逆变供电
	Bit 3	电池自检中	0: 不在自检; 1: 自检中
	Bits 5/4	均充/浮充	00: 浮充; 01: 均充; 10: 非充电状态
	Bit 6	开机/关机	0: 开机; 1: 关机
	Bit 7	发电机接入	0: 发电机接入; 1: 发电机没接入
	Bit 8	输入空开状态	0: 断开状态; 1: 闭合状态
	Bit 9	手动旁路空开状态	0: 断开状态; 1: 闭合状态
	Bit 10	自动旁路空开状态	0: 断开状态; 1: 闭合状态
	Bit 11	输出空开状态	0: 断开状态; 1: 闭合状态
	Bit 12	发电机工作状态	0: 非工作状态; 1: 正工作状态
	Bit 13	本机处于输出禁止状态、	0: 是; 1: 否
	Bit 14	并机系统处于输出禁止状态	0: 是; 1: 否
	Bit 15	未定义	
1041	Bits 2/1/0	UPS 机型属性	000: 单机 001: 热备份主机 010: 热备份从机 011: 并机通讯主机 100: 并机通讯从机
	Bits 15~3	未定义	

4. UPS 模拟量

ID	字节数	项目	值
1050	2	交流输入相电压 A	2200 对应 220.0Vac
1051	2	交流输入相电压 B	2200 对应 220.0Vac
1052	2	交流输入相电压 C	2200 对应 220.0Vac
1053	2	交流输出相电压 A	2200 对应 220.0Vac
1054	2	交流输出相电压 B	2200 对应 220.0Vac
1055	2	交流输出相电压 C	2200 对应 220.0Vac
1056	2	交流输出电流 A	1000 对应 100.0A
1057	2	交流输出电流 B	1000 对应 100.0A
1058	2	交流输出电流 C	1000 对应 100.0A
1059	2	直流输入电压 (电池电压)	1000 对应 100Vdc
1060	2	输出频率 (三相一致)	5000 对应 50.00Hz
1061	2	交流输入线电压 AB	3800 对应 380.0Vac
1062	2	交流输入线电压 BC	3800 对应 380.0Vac
1063	2	交流输入线电压 CA	3800 对应 380.0Vac
1064	2	A 相输入电流	1000 对应 100.0A
1065	2	B 相输入电流	1000 对应 100.0A
1066	2	C 相输入电流	1000 对应 100.0A
1067	2	输入频率 (三相一致)	5000 对应 50.00Hz
1068	2	输入功率因数 (三相一致)	100 对应 1
1069	2	A 相旁路电压	2200 对应 220.0Vac
1070	2	B 相旁路电压	2200 对应 220.0Vac
1071	2	C 相旁路电压	2200 对应 220.0Vac
1072	2	A 相旁路电流	1000 对应 100.0A
1073	2	B 相旁路电流	1000 对应 100.0A

ID	字节数	项目	值
1074	2	C 相旁路电流	1000 对应 100.0A
1075	2	旁路频率（三相一致）	5000 对应 50.00Hz
1076	2	电池温度	1000 对应 100 摄氏度
1077	2	A 相输出功率因数	100 对应 1
1078	2	B 相输出功率因数	100 对应 1
1079	2	C 相输出功率因数	100 对应 1
1080	2	A 相输出有功功率	10000 对应 100.00kW
1081	2	B 相输出有功功率	10000 对应 100.00kW
1082	2	C 相输出有功功率	10000 对应 100.00kW
1083	2	电池电流	1000 对应 100.0A
1084	2	电池剩余后备时间	1 对应 1 Minute
1085	2	A 相输出视在功率	10000 对应 100.00kVA
1086	2	B 相输出视在功率	10000 对应 100.00kVA
1087	2	C 相输出视在功率	10000 对应 100.00kVA
1088	2	A 相输出负载百分比	1000 对应 100.0%
1089	2	B 相输出负载百分比	1000 对应 100.0%
1090	2	C 相输出负载百分比	1000 对应 100.0%
1091	2	环境温度	1000 对应 100 摄氏度
1092	2	A 相输出峰值比	100 对应 1
1093	2	B 相输出峰值比	100 对应 1
1094	2	C 相输出峰值比	100 对应 1

3.2 UH31 UPS 协议文本

1. 产品基本信息

ID	字节数	项目	值
1000~1004	10	UPS 名称	"UH31 0200L"
1005	2	厂家软件版本	0x010B 对应 V1.11
1006~1015	20	厂家名称	"EmersonNetworkPower "
1019	2	适配卡软件版本	0x010B 对应 V1.11

2. UPS 告警量

ID	位	项目	值
1030	Bit 0	UPS 告警标志位	0: 正常; 1: 告警
	Bit 1	适配卡通讯故障位	0: 正常; 1: 故障
	Bit 2	未定义	
	Bit 3	同步/不同步	0: 正常; 1: 不同步
	Bits 5/4	市电电压 A 相	00: 正常 01: 低于下限 (掉电) 10: 高于上限 11: 超限
	Bits 7/6	市电电压 B 相	00: 正常 01: 低于下限 (掉电) 10: 高于上限 11: 超限
	Bits 9/8	市电电压 C 相	00: 正常 01: 低于下限 (掉电) 10: 高于上限 11: 超限
	Bit 10	整流器	0: 正常; 1: 故障
Bit 11	逆变器	0: 正常; 1: 故障	

ID	位	项目	值
1030	Bits 13/12	旁路电压	00: 正常; 01: 低于下限; 10: 超限
	Bits 15~14	未定义	
1031	Bits 2/1/0	蓄电池总电压 (正组)	000: 正常 001: 低于下限 (关机点) 010: 高于上限 (电压过高) 011: 故障 100: 预告警
	Bits 5/4/3	蓄电池总电压 (负组)	000: 正常 001: 低于下限 (关机点) 010: 高于上限 (电压过高) 011: 故障 100: 预告警
	Bit 6	充电器故障	0: 正常; 1: 故障
	Bit 7	输出短路	0: 正常; 1: 短路
	Bit 8	输出过载	0: 正常; 1: 过载
	Bit 9	散热器温度过高	0: 正常; 1: 过温
	Bit 10	市电频率	0: 正常; 1: 超限
	Bit 11	缺零故障	0: 正常; 1: 故障
	Bit 12	输入缺相	0: 正常; 1: 故障
	Bits 15~13	未定义	

3. UPS 状态量

ID	位	项目	值
1040	Bits 1/0	供电方式	00: 整流电池均不供电 01: 主路逆变供电 10: 电池逆变供电 11: 旁路供电
	Bit 2	电池自检中	0: 不在自检; 1: 自检中
	Bits 4/3	均充/浮充 (正组)	00: 浮充; 01: 均充; 10: 非充电状态
	Bits 6/5	均充/浮充 (负组)	00: 浮充; 01: 均充; 10: 非充电状态
	Bits 8/7	开机/关机	00: 开机; 01: 关机; 10: 正在关机
	Bits 15~9	未定义	

4. UPS 模拟量

ID	字节数	项目	值
1050	2	A 相输入电压	2200 对应 220.0Vac
1051	2	B 相输入电压	2200 对应 220.0Vac
1052	2	C 相输入电压	2200 对应 220.0Vac
1053	2	旁路电压	2200 对应 220.0Vac
1054	2	输入频率	5000 对应 50.00Hz
1055	2	输出电压	2200 对应 220.0Vac
1056	2	输出电流	1000 对应 100.0A
1057	2	输出频率	5000 对应 50.00Hz
1058	2	电池电压 (正组)	1000 对应 100Vdc
1059	2	电池电压 (负组)	1000 对应 100Vdc
1060	2	负载百分比	1000 对应 100.0%
1061	2	电池容量	1000 对应 100.0%
1062	2	机内温度	1000 对应 100 摄氏度

3.3 UH11 UPS 协议文本

1. 产品基本信息

ID	字节数	项目	值
1000~1004	10	UPS 名称	"UH11 0100L"
1005	2	厂家软件版本	0x010B 对应 V1.11
1006~1015	20	厂家名称	"EmersonNetworkPower "
1019	2	适配卡软件版本	0x010B 对应 V1.11

2. UPS 告警量

ID	位	项目	值
1030	Bit 0	UPS 告警标志位	0: 正常; 1: 告警
	Bit 1	适配卡通讯故障位	0: 正常; 1: 故障
	Bit 2	未定义	
	Bit 3	同步/不同步	0: 正常; 1: 不同步
	Bits 5/4	市电电压	00: 正常 01: 低于下限 (掉电) 10: 高于上限 11: 超限
	Bit 6	整流器	0: 正常; 1: 故障
	Bit 7	逆变器	0: 正常; 1: 故障
	Bits 9/8	旁路电压	00: 正常; 01: 低于下限 10: 高于上限
	Bits 12/11/10	蓄电池总电压	000: 正常 001: 低于下限 (关机点) 010: 高于上限 (电压过高) 011: 故障 100: 预告警
	Bit 13	充电器故障	0: 正常; 1: 故障
	Bit 14	零线/火线接反	0: 正常; 1: 接反
	Bit 15	输出短路	0: 正常; 1: 短路
1031	Bit 0	输出过载	0: 正常; 1: 过载
	Bit 1	散热器温度过高	0: 正常; 1: 过温
	Bit 2	市电频率	0: 正常; 1: 超限
	Bits 15~3	未定义	

3. UPS 状态量

ID	位	项目	值
1040	Bits 1/0	供电方式	00: 均不供电 01: 主路逆变供电 10: 电池逆变供电 11: 旁路供电
	Bit 2	电池自检中	0: 不在自检; 1: 自检中
	Bits 4/3	均充/浮充	00: 浮充; 01: 均充; 10: 非充电状态
	Bits 6/5	开机/关机	00: 开机; 01: 关机; 10: 正在关机
	Bits 15~7	未定义	

4. UPS 模拟量

ID	字节数	项目	值
1050	2	交流输入相电压	2200 对应 220.0Vac
1051	2	交流输出相电压	2200 对应 220.0Vac
1052	2	交流输出电流	1000 对应 100.0A
1053	2	电池电压	1000 对应 100Vdc
1054	2	输出频率	5000 对应 50.00Hz
1055	2	输入频率	5000 对应 50.00Hz
1056	2	负载百分比	1000 对应 100.0%
1057	2	电池容量	1000 对应 100.0%
1058	2	机内温度	1000 对应 100 摄氏度

3.4 iTrust 2G UPS 协议文本

1. 产品基本信息

ID	字节数	项目	值
1000~1004	10	UPS 名称	机架式/塔式 UPS 名称为: "UH11R0200L" 并联 UPS 名称为: "UP11 0200L"
1005	2	厂家软件版本	0x010B 对应 V1.11
1006~1015	20	厂家名称	"EmersonNetworkPower "
1019	2	适配卡软件版本	0x010B 对应 V1.11

2. UPS 告警量

ID	位	项目	值
1030	Bit 0	UPS 告警标志位	0: 正常; 1: 告警
	Bit 1	适配卡通讯故障位	0: 正常; 1: 故障
	Bit 2	未定义	
	Bits 4/3	市电电压状态	00: 正常 01: 低于下限 10: 高于上限 11: 故障
	Bits 6/5	旁路电压状态	00: 正常 01: 低于下限 10: 高于上限 11: 故障
	Bit 7	市电频率状态	0: 正常; 1: 异常
	Bit 8	旁路频率状态	0: 正常; 1: 异常
	Bit 9	充电模块状态	0: 正常; 1: 故障
	Bits 12/11/10	电池状态	000: 浮充 001: 故障 010: 电压低预告警 011: 自检 100: 放电 101: EOD 110: 均充 111: 非充电
Bits 15/14/13	1 号模块状态	000: 正常 001: 故障 010: 保护 011: 异常	

ID	位	项目	值
1030	Bits 15/14/13	1号模块状态	100: 通讯中断 101: 未知
1031	Bits 2/1/0	2号模块状态	000: 正常 001: 故障 010: 保护 011: 异常 100: 通讯中断 101: 未知
	Bits 5/4/3	3号模块状态	000: 正常 001: 故障 010: 保护 011: 异常 100: 通讯中断 101: 未知
	Bits 8/7/6	4号模块状态	000: 正常 001: 故障 010: 保护 011: 异常 100: 通讯中断 101: 未知
	Bits 11/10/9	5号模块状态	000: 正常 001: 故障 010: 保护 011: 异常 100: 通讯中断 101: 未知
	Bits 14/13/12	6号模块状态	000: 正常 001: 故障 010: 保护 011: 异常 100: 通讯中断 101: 未知
	Bit 15	未定义	

3. UPS 状态量

ID	位	项目	值
1040	Bits 1/0	供电方式	00: 整流电池均不供电 01: 主路逆变供电 10: 电池逆变供电 11: 旁路供电
	Bit 2	开关机状态	0: 开机状态 1: 关机状态
	Bit 3	电池自检允许状态	0: 允许自检 1: 不能自检
	Bit 4	过载切换状态	0: 允许回切逆变 1: 切换超次数, 不能回切逆变
	Bit 5	冗余台数状态	0: 冗余台数充足 1: 冗余台数不足
	Bits 15~6	未定义	

4. UPS 模拟量

ID	字节数	项目	值
1050	2	交流输入相电压	22000 对应 220.0Vac
1051	2	交流输出相电压	22000 对应 220.0Vac
1052	2	交流输出电流	10000 对应 100.0A
1053	2	输出频率	5000 对应 50.00Hz
1054	2	交流输入相电流	10000 对应 100.0A
1055	2	输入功率	10000 对应 100.00kW
1056	2	输入频率	5000 对应 50.00Hz
1057	2	输出有功功率	10000 对应 100.00kVA
1058	2	输出视在功率	10000 对应 100.00kVA
1059	2	电池后备时间	1000 对应 1000min
1060	2	电池电压	22000 对应 220.0V
1061	2	旁路电压	22000 对应 220.0Vac
1062	2	旁路电流	10000 对应 100.0A
1063	2	旁路频率	5000 对应 50.00Hz
1064	2	负载百分比	10000 对应 100.0%

3.5 iTrust Adapt 5/10kVA UPS 协议文本

1. 产品基本信息

ID	字节数	项目	值
1000~1004	10	UPS 名称	机架式/塔式 UPS 名称为: “UHA1R0050L”
1005	2	厂家软件版本	0x010B 对应 V1.11
1006~1015	20	厂家名称	“EmersonNetworkPower”
1019	2	适配卡软件版本	0x010B 对应 V1.11

2. UPS 告警量

ID	位	项目	值
1030	Bit 0	UPS 告警标志位	0: 正常; 1: 告警
	Bit 1	适配卡通讯故障位	0: 正常; 1: 故障
	Bit 2	未定义	
	Bit 3	同步/不同步状态	0: 正常; 1: 不同步
	Bits 5/4	市电状态	00: 正常; 01: 异常
	Bit 6	整流器状态	0: 正常; 1: 故障
	Bit 7	逆变器状态	0: 正常; 1: 故障
	Bits 9/8	旁路状态	00: 正常; 01: 异常
	Bits 11/10	蓄电池电压状态	00: 浮充 01: 低于下限 10: 高于上限 11: 故障
	Bit 12	散热器状态	0: 正常; 1: 过温
	Bit 13	风扇状态	0: 正常; 1: 异常
	Bit 14	缺零状态	0: 正常; 1: 异常
	1031	Bit 15	母线电压状态
Bit 0		充电模块状态	0: 正常; 1: 故障
Bit 1		电池 EOD 状态	0: 正常; 1: 电池 EOD
Bit 2		辅助电源状态	0: 正常; 1: 故障
Bit 3		输出过载状态	0: 正常; 1: 过载
	Bit 4	输出短路状态	0: 正常; 1: 短路

ID	位	项目	值
1031	Bit 5	过载超时状态	0: 正常; 1: 超时
	Bit 6	均流状态	0: 正常; 1: 故障
	Bit 7	并机线状态	0: 正常; 1: 故障
	Bit 8	并机地址冲突状态	0: 正常; 1: 故障
	Bit 9	并机通信状态	0: 正常; 1: 故障
	Bits 15~10	未定义	

3. UPS 状态量

ID	位	项目	值
1040	Bits 1/0	供电方式	00: 整流电池均不供电 01: 主路逆变供电 10: 电池逆变供电 11: 旁路供电
	Bits 3/2	电池充电状态	00: 浮充 01: 均充 10: 非充电非放电 11: 放电
	Bit 4	电池自检状态	0: 不在自检; 1: 自检中
	Bit 5	电池自检允许状态	0: 允许自检; 1: 不允许自检
	Bit 6	电池电压预告警状态	0: 电池电压正常 1: 电池电压低预告警
	Bit 7	开关机状态	0: 开机; 1: 关机
	Bits 15~8	未定义	

4. UPS 模拟量

ID	字节数	项目	值
1050	2	交流输入相电压 A	22000 对应 220.0Vac
1051	2	交流输入相电压 B	22000 对应 220.0Vac
1052	2	交流输入相电压 C	22000 对应 220.0Vac
1053	2	交流输出相电压	22000 对应 220.0Vac
1054	2	交流输出电流	10000 对应 100.0A
1055	2	电池电压	22000 对应 220.0Vdc
1056	2	输出频率	5000 对应 50.00Hz
1057	2	输入频率	5000 对应 50.00Hz
1058	2	旁路电压	22000 对应 220.0Vac
1059	2	旁路电流	10000 对应 100.0A
1060	2	交流输出有功功率	10000 对应 100.00kW
1061	2	交流输出视在功率	10000 对应 100.00kVA
1062	2	交流输出负载百分比	10000 对应 100.0%

3.6 NXa/NXb/NXe UPS 协议文本

1. 产品基本信息

ID	字节数	项目	值
1000~1004	10	UPS 名称	“UH33 0200L”
1005	2	厂家软件版本	0x010B 对应 V1.11
1006~1015	20	厂家名称	“EmersonNetworkPower”
1019	2	适配卡软件版本	0x010B 对应 V1.11

2. UPS 告警量

ID	位	项目	值
1030	Bit 0	UPS 告警标志位	0: 正常; 1: 告警
	Bit 1	适配卡通讯故障位	0: 正常; 1: 故障
	Bit 2	未定义	
	Bit 3	同步/不同步	0: 正常; 1: 不同步
	Bit 4	主路电压异常	0: 正常; 1: 异常
	Bit 5	整流器	0: 正常; 1: 故障
	Bit 6	逆变器	0: 正常; 1: 故障
	Bit 7	旁路情况 (电压或频率)	0: 正常; 1: 超限
	Bits 10/9/8	蓄电池总电压状态	000: 正常 001: 低于下限 (关机点) 010: 高于上限 (电压过高) 011: 电池无 100: 预告警 101: 电池接反
	Bit 11	主路频率异常	0: 正常; 1: 超限
	Bit 12	平衡电感过温	0: 正常; 1: 过温
	Bit 13	输入电感过温	0: 正常; 1: 过温
	Bit 14	整流器过温	0: 正常; 1: 过温
	Bit 15	平衡电路故障	0: 正常; 1: 故障
	1031	Bit 0	平衡电路过流
Bit 1		电池接触器故障	0: 正常; 1: 故障
Bit 2		电池变换器故障	0: 正常; 1: 故障
Bit 3		电池变换器过流	0: 正常; 1: 过流
Bit 4		电池变换器过温	0: 正常; 1: 过温
Bit 5		主路熔丝断	0: 正常; 1: 断
Bit 6		辅助电源 1 掉电	0: 正常; 1: 故障
Bit 7		主路相序反	0: 正常; 1: 故障
Bit 8		整流器过流	0: 正常; 1: 故障
Bit 9		软启动失败	0: 正常; 1: 故障
Bit 10		旁路过流故障	0: 正常; 1: 故障
Bit 11		逆变电感过温	0: 正常; 1: 过温
Bit 12		逆变器过温	0: 正常; 1: 过温
Bit 13		风扇故障	0: 正常; 1: 故障
Bit 14		逆变晶闸管故障	0: 正常; 1: 故障
Bit 15	旁路晶闸管故障	0: 正常; 1: 故障	
1032	Bit 0	用户操作错误	0: 正常; 1: 错误
	Bit 1	输出熔丝断	0: 正常; 1: 断
	Bit 2	辅助电源 2 掉电	0: 正常; 1: 掉电
	Bit 3	单机输出过载	0: 正常; 1: 过载
	Bit 4	并机系统过载	0: 正常; 1: 过载
	Bit 5	单机过载超时	0: 正常; 1: 过载超时
	Bit 6	旁路异常关机	0: 正常; 1: 异常
	Bit 7	交流输出过压	0: 正常; 1: 故障
	Bit 8	逆变器过流	0: 正常; 1: 故障
	Bit 9	旁路相序反	0: 正常; 1: 故障
	Bit 10	负载冲击转旁路	0: 正常; 1: 故障
	Bit 11	旁路切换次数限制	0: 正常; 1: 故障
	Bit 12	并机均流故障	0: 正常; 1: 故障
	Bit 13	母线异常关机	0: 正常; 1: 故障
	Bit 14	邻机请求转旁路	0: 正常; 1: 故障
Bit 15	并机板故障	0: 正常; 1: 故障	

ID	位	项目	值
1033	Bit 0	直流母线过压故障	0: 正常; 1: 故障
	Bit 1	并机线连接故障	0: 正常; 1: 故障
	Bit 2	环境温度过高	0: 正常; 1: 故障
	Bit 3	整流通讯故障	0: 正常; 1: 故障
	Bit 4	逆变通讯故障	0: 正常; 1: 故障
	Bit 5	并机通讯故障	0: 正常; 1: 故障
	Bit 6	输出直流分量过大故障	0: 正常; 1: 故障
	Bit 7	并机系统电池预告警故障	0: 正常; 1: 故障
	Bit 8	输入缺零故障	0: 正常; 1: 故障
	Bit 9	逆变接触器故障	0: 正常; 1: 故障
	Bit 10	充电器故障	0: 正常; 1: 故障
	Bits 12/11	蓄电池寿命情况	00: 正常 01: 电池需更换 10: 电池寿命终结
	Bit 13	紧急关机	0: 正常; 1: 故障
	Bit 14	电池温度过高	0: 正常; 1: 故障
Bit 15	未定义		
1034	Bit 0	BCB 接入情况	00: BCB 未接入 01: BCB 闭合 10: BCB 断开
	Bit 2	电池接地故障	0: 正常; 1: 故障
	Bits 15~3	未定义	

3. UPS 状态量

ID	位	项目	值
1040	Bits 2/1/0	供电方式	000: 整流电池均不供电 001: 主路逆变供电 010: 电池逆变供电 011: 旁路供电 100: 联合逆变供电
	Bit 3	电池自检中	0: 不在自检; 1: 自检中
	Bits 5/4	均充/浮充	00: 浮充; 01: 均充 10: 非充电状态
	Bit 6	开机/关机	0: 关机; 1: 开机
	Bit 7	发电机接入	0: 发电机接入 1: 发电机没接入
	Bit 8	输入空开状态	0: 断开状态; 1: 闭合状态
	Bit 9	维修旁路空开状态	0: 断开状态; 1: 闭合状态
	Bit 10	旁路空开状态	0: 断开状态; 1: 闭合状态
	Bit 11	输出空开状态	0: 断开状态; 1: 闭合状态
	Bits 14/13/12	旋转空开状态	000: 关闭状态 001: 测试状态 010: 正常状态 011: 旁路状态 100: 维修状态
Bit 15	未定义		
1041	Bits 1/0	并机系统供电状态	00: 主路逆变供电 01: 电池逆变供电 10: 旁路供电 11: 均不供电
	Bits 15~2	未定义	

4. UPS 模拟量

ID	字节数	项目	值
1050	2	交流输入相电压 A	2200 对应 220.0Vac
1051	2	交流输入相电压 B	2200 对应 220.0Vac
1052	2	交流输入相电压 C	2200 对应 220.0Vac
1053	2	交流输出相电压 A	2200 对应 220.0Vac
1054	2	交流输出相电压 B	2200 对应 220.0Vac
1055	2	交流输出相电压 C	2200 对应 220.0Vac
1056	2	交流输出电流 A	1000 对应 100.0A
1057	2	交流输出电流 B	1000 对应 100.0A
1058	2	交流输出电流 C	1000 对应 100.0A
1059	2	电池电压	1000 对应 100Vdc
1060	2	输出频率（三相一致）	5000 对应 50.00Hz
1061	2	交流输入线电压 AB	3800 对应 380.0Vac
1062	2	交流输入线电压 BC	3800 对应 380.0Vac
1063	2	交流输入线电压 CA	3800 对应 380.0Vac
1064	2	A 相输入电流	1000 对应 100.0A
1065	2	B 相输入电流	1000 对应 100.0A
1066	2	C 相输入电流	1000 对应 100.0A
1067	2	输入频率（三相一致）	5000 对应 50.00Hz
1068	2	A 相输入功率因数	100 对应 1
1069	2	B 相输入功率因数	100 对应 1
1070	2	C 相输入功率因数	100 对应 1
1071	2	A 相旁路电压	2200 对应 220.0Vac
1072	2	B 相旁路电压	2200 对应 220.0Vac
1073	2	C 相旁路电压	2200 对应 220.0Vac
1074	2	旁路频率（三相一致）	5000 对应 50.00Hz
1075	2	电池电流	1000 对应 100.0A
1076	2	A 相输出功率因数	100 对应 1
1077	2	B 相输出功率因数	100 对应 1
1078	2	C 相输出功率因数	100 对应 1
1079	2	本机 A 相输出峰值比	100 对应 1
1080	2	本机 B 相输出峰值比	100 对应 1
1081	2	本机 C 相输出峰值比	100 对应 1
1082	2	本机 A 相输出有功功率	10000 对应 100.00kW
1083	2	本机 B 相输出有功功率	10000 对应 100.00kW
1084	2	本机 C 相输出有功功率	10000 对应 100.00kW
1085	2	本机 A 相输出视在功率	10000 对应 100.00kVA
1086	2	本机 B 相输出视在功率	10000 对应 100.00kVA
1087	2	本机 C 相输出视在功率	10000 对应 100.00kVA
1088	2	本机 A 相输出负载百分比	1000 对应 100.0%
1089	2	本机 B 相输出负载百分比	1000 对应 100.0%
1090	2	本机 C 相输出负载百分比	1000 对应 100.0%
1091	2	本机 A 相输出无功功率	10000 对应 100.00kVA
1092	2	本机 B 相输出无功功率	10000 对应 100.00kVA
1093	2	本机 C 相输出无功功率	10000 对应 100.00kVA
1094	2	系统 A 相输出有功功率	10000 对应 100.00kW
1095	2	系统 B 相输出有功功率	10000 对应 100.00kW
1096	2	系统 C 相输出有功功率	10000 对应 100.00kW
1097	2	系统 A 相输出视在功率	10000 对应 100.00kVA
1098	2	系统 B 相输出视在功率	10000 对应 100.00kVA
1099	2	系统 C 相输出视在功率	10000 对应 100.00kVA

ID	字节数	项目	值
1100	2	系统 A 相输出无功功率	10000 对应 100.00kVA
1101	2	系统 B 相输出无功功率	10000 对应 100.00kVA
1102	2	系统 C 相输出无功功率	10000 对应 100.00kVA
1103	2	电池后备时间	1 对应 1 Minute
1104	2	电池温度	1000 对应 100 摄氏度
1105	2	环境温度	1000 对应 100 摄氏度
1106	2	负电池电压	1000 对应 100Vdc
1107	2	负电池电流	1000 对应 100.0A

3.7 Hipulse U UPS 和 FLP 协议文本

1. 产品基本信息

ID	字节数	项目	值
1000~1004	10	UPS 名称	“HL33 0200L”
1005	2	厂家软件版本	“0100”对应 V1.0
1006~1015	20	厂家名称	“EmersonNetworkPower”
1019	2	适配卡软件版本	“0x1234” 对应 Ver12.34

2. UPS 告警量

ID	位	项目	值
1030	Bit 0	UPS 告警标志位	0: 正常; 1: 告警
	Bit 1	适配卡通讯故障位	0: 正常; 1: 故障
	Bit 2	未定义	
	Bit 3	同步/不同步	0: 正常; 1: 不同步
	Bit 4	主路电压异常	0: 正常; 1: 异常
	Bit 5	整流器封锁	0: 正常; 1: 故障
	Bit 6	逆变器输出电压异常	0: 正常; 1: 异常
	Bit 7	旁路情况 (电压或频率)	0: 正常; 1: 超限
	Bits 10/9/8	蓄电池总电压状态	000: 正常 001: 低于下限 (关机点) 010: 高于上限 (电压过高) 011: 电池无 100: 预告警 101: 电池接反
	Bit 11	主路频率异常	0: 正常; 1: 超限
	Bit 12	主路熔丝断	0: 正常; 1: 断
	Bit 13	主路相序反	0: 正常; 1: 故障
Bit 14	主路缺相故障	0: 正常; 1: 故障	
Bit 15	辅助电源 1 掉电	0: 正常; 1: 故障	
1031	Bit 0	辅助电源 2 掉电	0: 正常; 1: 故障
	Bit 1	整流器限流	0: 正常; 1: 故障
	Bit 2	软启动失败	0: 正常; 1: 故障
	Bit 3	整流器过温	0: 正常; 1: 过温
	Bit 4	输入滤波器故障	0: 正常; 1: 故障
	Bit 5	滤波器切换次数到	0: 正常; 1: 故障
	Bit 6	滤波器接触器故障	0: 正常; 1: 故障
	Bit 7	整流器驱动电缆故障	0: 正常; 1: 故障
	Bit 8	整流通讯故障	0: 正常; 1: 故障
	Bit 9	逆变器过温	0: 正常; 1: 过温
	Bit 10	风扇故障	0: 正常; 1: 故障
Bit 11	逆变晶闸管故障	0: 正常; 1: 故障	

ID	位	项目	值
1031	Bit 12	旁路晶闸管故障	0: 正常; 1: 故障
	Bit 13	用户操作错误	0: 正常; 1: 错误
	Bit 14	单机输出过载	0: 正常; 1: 过载
	Bit 15	并机系统过载	0: 正常; 1: 过载
1032	Bit 0	单机过载超时	0: 正常; 1: 过载超时
	Bit 1	旁路异常关机	0: 正常; 1: 故障
	Bit 2	交流输出过压	0: 正常; 1: 故障
	Bit 3	逆变器过流	0: 正常; 1: 故障
	Bit 4	旁路相序反	0: 正常; 1: 故障
	Bit 5	负载冲击转旁路	0: 正常; 1: 故障
	Bit 6	旁路切换次数限制	0: 正常; 1: 故障
	Bit 7	并机均流故障	0: 正常; 1: 故障
	Bit 8	母线异常关机	0: 正常; 1: 故障
	Bit 9	邻机请求转旁路	0: 正常; 1: 故障
	Bit 10	并机板故障	0: 正常; 1: 故障
	Bit 11	并机线连接故障	0: 正常; 1: 故障
	Bit 12	并机通讯故障	0: 正常; 1: 故障
	Bit 13	旁路过流故障	0: 正常; 1: 故障
	Bits 15/14	LBS 激活/故障	00: 未激活; 01: 激活; 10: 故障
1033	Bit 0	旁路电感过温	0: 正常; 1: 过温
	Bit 1	静态开关过温	0: 正常; 1: 过温
	Bit 2	旁路反灌故障	0: 正常; 1: 告警
	Bit 3	逆变器驱动电缆故障	0: 正常; 1: 故障
	Bit 4	逆变通讯故障	0: 正常; 1: 故障
	Bit 5	并机系统电池预告警故障	0: 正常; 1: 故障
	Bit 6	紧急关机	0: 正常; 1: 紧急关机
	Bit 7	环境温度过高	0: 正常; 1: 故障
	Bits 9/8	蓄电池寿命情况	00: 正常 01: 电池需维护 10: 电池寿命终结
	Bit 10	电池温度过高	0: 正常; 1: 故障
	Bit 11	电池接地故障	0: 正常; 1: 故障
	Bit 12	电池熔丝断	0: 正常; 1: 故障
	Bits 14/13	BCB 接入情况	00: BCB 未接入 01: BCB 闭合 10: BCB 断开
	Bit 15	输出熔丝断 (预留)	0: 正常; 1: 故障
	1034	Bit 0	母线电容过压
Bit 1		母线过压	0: 正常; 1: 故障
Bits 15~2		未使用	

3. UPS 状态量

ID	位	项目	值
1040	Bits 2/1/0	供电方式	000: 均不供电 001: 主路逆变供电 010: 电池逆变供电 011: 旁路供电 100: 联合逆变供电
	Bit 3	电池自检中	0: 不在自检; 1: 自检中
	Bits 5/4	均充/浮充	00: 浮充; 01: 均充; 10: 非充电状态

ID	位	项目	值
1040	Bit 6	开机/关机	0: 关机; 1: 开机
	Bit 7	发电机接入	0: 发电机接入 1: 发电机没接入
	Bit 8	输入空开状态	0: 断开状态; 1: 闭合状态
	Bit 9	维修旁路空开状态	0: 断开状态; 1: 闭合状态
	Bit 10	旁路空开状态	0: 断开状态; 1: 闭合状态
	Bit 11	输出空开状态	0: 断开状态; 1: 闭合状态
	Bits 13/12	并机系统供电状态	00: 主路逆变供电 01: 电池逆变供电 10: 旁路供电 11: 均不供电
Bits 15/14	未使用		
1041	Bits 2/1/0	旋转空开状态	000: 关闭状态 001: 测试状态 010: 正常状态 011: 旁路状态 100: 维修状态
	Bits 15~3	未使用	

4. UPS 模拟量

ID	字节数	项目	值
1050	2	交流输出相电压 A	2200 对应 220.0Vac
1051	2	交流输出相电压 B	2200 对应 220.0Vac
1052	2	交流输出相电压 C	2200 对应 220.0Vac
1053	2	交流输出电流 A	1000 对应 100.0A
1054	2	交流输出电流 B	1000 对应 100.0A
1055	2	交流输出电流 C	1000 对应 100.0A
1056	2	电池电压	1000 对应 100Vdc
1057	2	输出频率 (三相一致)	5000 对应 50.00Hz
1058	2	交流输入线电压 AB	3800 对应 380.0Vac
1059	2	交流输入线电压 BC	3800 对应 380.0Vac
1060	2	交流输入线电压 CA	3800 对应 380.0Vac
1061	2	A 相输入电流	1000 对应 100.0A
1062	2	B 相输入电流	1000 对应 100.0A
1063	2	C 相输入电流	1000 对应 100.0A
1064	2	输入频率 (三相一致)	5000 对应 50.00Hz
1065	2	总输入功率因数	100 对应 1
1066	2	A 相旁路电压	2200 对应 220.0Vac
1067	2	B 相旁路电压	2200 对应 220.0Vac
1068	2	C 相旁路电压	2200 对应 220.0Vac
1069	2	旁路频率 (三相一致)	5000 对应 50.00Hz
1070	2	电池电流	1000 对应 100.0A
1071	2	A 相输出功率因数	100 对应 1
1072	2	B 相输出功率因数	100 对应 1
1073	2	C 相输出功率因数	100 对应 1
1074	2	本机 A 相输出峰值比	100 对应 1
1075	2	本机 B 相输出峰值比	100 对应 1
1076	2	本机 C 相输出峰值比	100 对应 1
1077	2	本机 A 相输出有功功率	10000 对应 100.00kW
1078	2	本机 B 相输出有功功率	10000 对应 100.00kW
1079	2	本机 C 相输出有功功率	10000 对应 100.00kW
1080	2	本机 A 相输出视在功率	10000 对应 100.00kVA

ID	字节数	项目	值
1081	2	本机 B 相输出视在功率	10000 对应 100.00kVA
1082	2	本机 C 相输出视在功率	10000 对应 100.00kVA
1083	2	本机 A 相输出负载百分比	1000 对应 100.0%
1084	2	本机 B 相输出负载百分比	1000 对应 100.0%
1085	2	本机 C 相输出负载百分比	1000 对应 100.0%
1086	2	本机 A 相输出无功功率	10000 对应 100.00kVA
1087	2	本机 B 相输出无功功率	10000 对应 100.00kVA
1088	2	本机 C 相输出无功功率	10000 对应 100.00kVA
1089	2	系统 A 相输出有功功率	10000 对应 100.00kW
1090	2	系统 B 相输出有功功率	10000 对应 100.00kW
1091	2	系统 C 相输出有功功率	10000 对应 100.00kW
1092	2	系统 A 相输出视在功率	10000 对应 100.00kVA
1093	2	系统 B 相输出视在功率	10000 对应 100.00kVA
1094	2	系统 C 相输出视在功率	10000 对应 100.00kVA
1095	2	系统 A 相输出无功功率	10000 对应 100.00kVA
1096	2	系统 B 相输出无功功率	10000 对应 100.00kVA
1097	2	系统 C 相输出无功功率	10000 对应 100.00kVA
1098	2	电池后备时间	1 对应 1 分钟
1099	2	电池温度	1000 对应 100 摄氏度
1100	2	环境温度	1000 对应 100 摄氏度
1101	2	电池老化系数	10000 对应 100

3.8 NXr 和 iTrust Adapt 16/20kVA UPS 协议文本

1. 产品基本信息

ID	字节数	项目	值
1000~1004	10	UPS 名称	如“HR331500”
1005	2	厂家软件版本	0x0201 对应 V2.01
1006~1015	20	厂家名称	“EmersonNetworkPower”
1019	2	适配卡软件版本	0x0201 对应 V2.01

2. UPS 告警量

ID	位	项目	值
1030	Bit 0	UPS 告警标志位	0: 正常; 1: 告警
	Bit 1	适配卡通讯故障位	0: 正常; 1: 故障
	Bit 2	未定义	
	Bit 3	逆变器同步/不同步	0: 同步; 1: 不同步
	Bit 4	市电电压	0: 正常; 1: 异常
	Bit 5	整流器状态	0: 正常; 1: 故障
	Bit 6	逆变器状态	0: 正常; 1: 故障
	Bit 7	旁路情况 (电压或频率)	0: 正常; 1: 超限
	Bits 8/9/10	电池组 1 状态	000: 正常 001: 低于下限 (关机点) 010: 高于上限 (电压过高) 011: 电池无 100: 预告警 101: 电池接反
	Bit 11	功率模块 1 故障	0: 正常; 1: 异常
Bit 12	功率模块 2 故障	0: 正常; 1: 异常	
Bit 13	功率模块 3 故障	0: 正常; 1: 异常	

ID	位	项目	值
1030	Bit 14	功率模块 4 故障	0: 正常; 1: 异常
	Bit 15	功率模块 5 故障	0: 正常; 1: 异常
1031	Bit 0	功率模块 6 故障	0: 正常; 1: 异常
	Bit 1	功率模块 7 故障	0: 正常; 1: 异常
	Bit 2	功率模块 8 故障	0: 正常; 1: 异常
	Bit 3	功率模块 9 故障	0: 正常; 1: 异常
	Bit 4	功率模块 10 故障	0: 正常; 1: 异常
	Bit 5	LBS 异常	0: 正常; 1: 异常
	Bit 6/7	键盘板故障或机型容量无效	00: 正常; 01: 键盘板故障 10: 机型容量无效
	Bit 8	风扇故障	0: 正常; 1: 故障
	Bit 9	环境温度过高	0: 正常; 1: 过温
	Bit 10	紧急关机	0: 正常; 1: 紧急关机
	Bit 11	旁路晶闸管故障	0: 正常; 1: 故障
	Bit 12	旁路相序反	0: 正常; 1: 故障
	Bit 13	旁路过流故障	0: 正常; 1: 故障
	Bit 14	旁路异常关机	0: 正常; 1: 异常
	Bit 15	旁路切换次数限制	0: 正常; 1: 故障
1032	Bit 0	模块并机板故障	0: 正常; 1: 故障
	Bit 1	模块并机线连接故障	0: 正常; 1: 故障
	Bit 2	模块并机通讯故障	0: 正常; 1: 故障
	Bit 3	辅助电源 2 掉电	0: 正常; 1: 故障
	Bit 4	接触器电源板 1 故障	0: 正常; 1: 故障
	Bit 5	接触器电源板 2 故障	0: 正常; 1: 故障
	Bit 6	冗余风扇电源故障	0: 正常; 1: 异常
	Bit 8/7	BCB 接入情况	00: BCB 未接入; 01: BCB 闭合 03: BCB 断开
	Bit 9	电池组 1 接触器故障	0: 正常; 1: 故障
	Bit 10	电池组 2 接触器故障	0: 正常; 1: 故障
	Bit 11	电池组 1 变换器故障	0: 正常; 1: 故障
	Bit 12	电池组 2 变换器故障	0: 正常; 1: 故障
	Bit 13	电池组 1 变换器过流	0: 正常; 1: 过流
	Bit 14	电池组 2 变换器过流	0: 正常; 1: 过流
Bits 15	电池组 1 变换器过温	0: 正常; 1: 过温	
1033	Bit 0	电池组 2 变换器过温	0: 正常; 1: 过温
	Bit 1	电池组 1 充电器故障	0: 正常; 1: 故障
	Bit 2	电池组 2 充电器故障	0: 正常; 1: 故障
	Bit 4/3	电池组 1 寿命情况	00: 正常; 01: 电池需更换 10: 电池寿命终结
	Bit 6/5	电池组 2 寿命情况	00: 正常; 01: 电池需更换 10: 电池寿命终结
	Bit 7	电池组 1 温度过高	0: 正常; 1: 过高
	Bit 8	电池组 2 温度过高	0: 正常; 1: 过高
	Bit 9	电池组 1 接地故障	0: 正常; 1: 故障
	Bits 10	电池组 2 接地故障	0: 正常; 1: 故障
	Bit 11	主路频率异常	0: 正常; 1: 超限
	Bit 12	平衡电感过温	0: 正常; 1: 过温
	Bit 13	输入电感过温	0: 正常; 1: 过温
	Bits 14	整流器过温	0: 正常; 1: 过温
	Bit 15	平衡电路故障	0: 正常; 1: 故障

ID	位	项目	值
1034	Bit 0	平衡电路过流	0: 正常; 1: 过流
	Bit 1	主路熔断	0: 正常; 1: 断
	Bit 2	辅助电源 1 掉电	0: 正常; 1: 故障
	Bit 3	主路相序反	0: 正常; 1: 故障
	Bit 4	整流器过流	0: 正常; 1: 故障
	Bit 5	软启动失败	0: 正常; 1: 故障
	Bit 6	逆变电感过温	0: 正常; 1: 过温
	Bit 7	逆变器过温	0: 正常; 1: 过温
	Bit 8	逆变晶闸管故障	0: 正常; 1: 故障
	Bit 9	用户操作错误	0: 正常; 1: 错误
	Bit 10	输出熔断	0: 正常; 1: 断
	Bit 11	单机输出过载	0: 正常; 1: 过载
	Bit 12	并机系统过载	0: 正常; 1: 过载
	Bit 13	单机过载超时	0: 正常; 1: 过载超时
	Bit 14	交流输出过压	0: 正常; 1: 过压
Bit 15	逆变器过流	0: 正常; 1: 过流	
1035	Bit 0	负载冲击转旁路	0: 正常; 1: 故障
	Bit 1	并机均流故障	0: 正常; 1: 故障
	Bit 2	母线异常关	0: 正常; 1: 故障
	Bit 3	邻机请求转旁路	0: 正常; 1: 故障
	Bit 4	直流母线过压故障	0: 正常; 1: 故障
	Bit 5	整流通讯故障	0: 正常; 1: 故障
	Bit 6	逆变通讯故障	0: 正常; 1: 故障
	Bit 7	输出直流分量过大故障	0: 正常; 1: 故障
	Bit 8	并机系统电池预告警故障	0: 正常; 1: 故障
	Bit 9	输入缺零故障	0: 正常; 1: 故障
	Bit 10	逆变接触器故障	0: 正常; 1: 故障
	Bit 11	输入接触器故障	0: 正常; 1: 故障
	Bit 12	输入电流异常	0: 正常; 1: 故障
	Bit 13	输出电压异常	0: 正常; 1: 故障
	Bit 14	输入电流超限	0: 正常; 1: 故障
Bit 15	旁路过温	0: 正常; 1: 故障	
1036	Bit 0	邻机晶闸管故障	0: 正常; 1: 故障
	Bit 1~15	预留	

3. UPS 状态量

ID	位	项目	值
1040	Bits 1/0	供电方式	00: UPS 供电 01: 旁路供电 10: 均不供电
	Bit 2	电池组 1 电池自检	0: 不在自检; 1: 自检中
	Bits 4/3	电池组 1 均充浮充	00: 浮充; 01: 均充; 10: 非充电状态
	Bit 5	整机开机/关机	0: 关机; 1: 开机
	Bit 7/6	整流器供电状态	00: 主路输入, 整流器开启 01: 电池输入, 整流器开启 10: 联合输入, 整流器开启 11: 主路、电池均无输入
	Bit 8	整机发电机接入事件	0: 发电机接入; 1: 发电机未接入
	Bit 9	整机输入空开状态	0: 断开状态; 1: 闭合状态
	Bit 10	整机维修旁路空开状态	0: 断开状态; 1: 闭合状态
	Bit 11	整机旁路空开状态	0: 断开状态; 1: 闭合状态

ID	位	项目	值
1040	Bit 12	整机输出空开状态	0: 断开状态; 1: 闭合状态
	Bits 5/14/13	整机旋转空开状态	000: 关闭状态 001: 测试状态 010: 正常状态 011: 旁路状态 100: 维修状态
1041	Bits 2/1/0	机架并机系统供电状态	000: 均不供电 001: 旁路供电 010: 市电供电 011: 电池逆变供电 100: 联合供电 101: 输出禁止
	Bit 3	电池组 2 电池自检	0: 自检中; 1: 没在自检
	Bit 5/4	电池组 2 浮充/均充状态	00: 浮充 01: 均充 10: 非充电状态
	Bit 6	模块 1 在线状态	0: 在线; 1: 不在线
	Bit 7	模块 2 在线状态	0: 在线; 1: 不在线
	Bit 8	模块 3 在线状态	0: 在线; 1: 不在线
	Bit 9	模块 4 在线状态	0: 在线; 1: 不在线
	Bit 10	模块 5 在线状态	0: 在线; 1: 不在线
	Bit 11	模块 6 在线状态	0: 在线; 1: 不在线
	Bit 12	模块 7 在线状态	0: 在线; 1: 不在线
	Bit 13	模块 8 在线状态	0: 在线; 1: 不在线
	Bit 14	模块 9 在线状态	0: 在线; 1: 不在线
	Bit 15	模块 10 在线状态	0: 在线; 1: 不在线

4. UPS 模拟量

ID	字节数	项目	值
1050	2	输入相电压 A	0.1V
1051	2	输入相电压 B	0.1V
1052	2	输入相电压 C	0.1V
1053	2	输出相电压 A	0.1V
1054	2	输出相电压 B	0.1V
1055	2	输出相电压 C	0.1V
1056	2	输出相电流 A	0.1A
1057	2	输出相电流 B	0.1A
1058	2	输出相电流 C	0.1A
1059	2	直流输入电压 (电池 1 电压)	0.1V
1060	2	输出频率 (三相一致)	0.01Hz
1061	2	输入线电压 AB	0.1V
1062	2	输入线电压 BC	0.1V
1063	2	输入线电压 CA	0.1V
1064	2	输入相电流 A	0.1A
1065	2	输入相电流 B	0.1A
1066	2	输入相电流 C	0.1A
1067	2	输入频率 (三相一致)	0.01Hz
1068	2	A 相输入功率因数	0.01
1069	2	B 相输入功率因数	0.01
1070	2	C 相输入功率因数	0.01
1071	2	旁路相电压 A	0.1V
1072	2	旁路相电压 B	0.1V

ID	字节数	项目	值
1073	2	旁路相电压 C	0.1V
1074	2	旁路频率	0.01Hz
1075	2	A 相输出功率因数	0.01
1076	2	B 相输出功率因数	0.01
1077	2	C 相输出功率因数	0.01
1078	2	A 相输出峰值比	0.01
1079	2	B 相输出峰值比	0.01
1080	2	C 相输出峰值比	0.01
1081	2	A 相输出有功功率	0.01kW
1082	2	B 相输出有功功率	0.01kW
1083	2	C 相输出有功功率	0.01kW
1084	2	A 相输出无功功率	0.01kVA
1085	2	B 相输出无功功率	0.01kVA
1086	2	C 相输出无功功率	0.01kVA
1087	2	A 相输出视在功率	0.01kVA
1088	2	B 相输出视在功率	0.01kVA
1089	2	C 相输出视在功率	0.01kVA
1090	2	电池后备时间	Minute
1091	2	正电池电压	0.1V
1092	2	正电池电流	0.1A
1093	2	负电池电压	0.1V
1094	2	负电池电流	0.1A
1095	2	电池老化系数	0.1
1096	2	电池温度	0.1℃
1097	2	环境温度	0.1℃

3.9 APM 150 UPS 协议文本

1. 产品基本信息

ID	字节数	项目	值
1000~1004	10	UPS 名称	APM 150 UPS 名称为：“APM 150”
1005	2	UPS 软件版本	0x0210 对应 V2.10
1006~1015	20	厂家名称	“EmersonNetworkPower”
1016	6	UPS 扩展名称	预留
1019	2	MODBUS 卡/干接点卡软件版本	0x0210 对应 V2.10

2. UPS 告警量

ID	位	项目	值
1030	Bit 0	UPS 总告警标志位	0: 正常; 1: 告警
	Bit 1	Modbus 卡/干节点卡通讯故障标志位	0: 正常; 1: 故障
	Bit 2	未定义	
	Bit 3	逆变器同步/不同步状态	0: 正常; 1: 不同步
	Bit 4	市电电压状态	0: 正常; 1: 异常
	Bit 5	整流器状态	0: 正常; 1: 故障
	Bit 6	逆变器状态	0: 正常; 1: 故障
	Bit 7	旁路状态	0: 正常; 1: 超限

ID	位	项目	值
1030	Bits 10/9/8	电池组 1 状态	000: 正常 001: 低于下限 (关机点) 010: 高于上限 (电压过高) 011: 电池无 100: 预告警 101: 电池接反
	Bit 11	功率模块 1 故障	0: 正常; 1: 异常
	Bit 12	功率模块 2 故障	0: 正常; 1: 异常
	Bit 13	功率模块 3 故障	0: 正常; 1: 异常
	Bit 14	功率模块 4 故障	0: 正常; 1: 异常
1031	Bit 15	功率模块 5 故障	0: 正常; 1: 异常
	Bit 0	功率模块 6 故障	0: 正常; 1: 异常
	Bit 1	功率模块 7 故障	0: 正常; 1: 异常
	Bit 2	功率模块 8 故障	0: 正常; 1: 异常
	Bit 3	功率模块 9 故障	0: 正常; 1: 异常
	Bit 4	功率模块 10 故障	0: 正常; 1: 异常
	Bit 5	LBS 异常	0: 正常; 1: 异常
	Bits 7/6	键盘板故障或机型容量无效	00: 正常; 01: 键盘板故障; 10: 机型容量无效
	Bit 8	风扇故障	0: 正常; 1: 故障
	Bit 9	环境温度过高	0: 正常; 1: 过温
	Bit 10	紧急关机	0: 正常; 1: 紧急关机
	Bit 11	旁路晶闸管故障	0: 正常; 1: 故障
	Bit 12	旁路相序反	0: 正常; 1: 故障
	Bit 13	旁路过流故障	0: 正常; 1: 故障
Bit 14	旁路异常关机	0: 正常; 1: 异常	
Bit 15	旁路切换次数限制	0: 正常; 1: 故障	
1032	Bit 0	模块并机板故障	0: 正常; 1: 故障
	Bit 1	模块并机线连接故障	0: 正常; 1: 故障
	Bit 2	模块并机通讯故障	0: 正常; 1: 故障
	Bit 3	辅助电源 2 掉电	0: 正常; 1: 故障
	Bit 4	接触器电源板 1 故障	0: 正常; 1: 故障
	Bit 5	接触器电源板 2 故障	0: 正常; 1: 故障
	Bit 6	冗余风扇电源故障	0: 正常; 1: 异常
	Bits 8/7	BCB 接入情况	00: BCB 未接入; 01: BCB 闭合; 10: BCB 断开
	Bit 9	电池组 1 接触器故障	0: 正常; 1: 故障
	Bit 10	电池组 2 接触器故障	0: 正常; 1: 故障
	Bit 11	电池组 1 变换器故障	0: 正常; 1: 故障
	Bit 12	电池组 2 变换器故障	0: 正常; 1: 故障
	Bit 13	电池组 1 变换器过流	0: 正常; 1: 过流
	Bit 14	电池组 2 变换器过流	0: 正常; 1: 过流
Bit 15	电池组 1 变换器过温	0: 正常; 1: 过温	
1033	Bit 0	电池组 2 变换器过温	0: 正常; 1: 过温
	Bit 1	电池组 1 充电器故障	0: 正常; 1: 故障
	Bit 2	电池组 2 充电器故障	0: 正常; 1: 故障
	Bits 4/3	电池组 1 寿命情况	00: 正常; 01: 电池需更换; 10: 电池寿命终结
	Bits 6/5	电池组 2 寿命情况	00: 正常; 01: 电池需更换; 10: 电池寿命终结
	Bit 7	电池组 1 温度过高	0: 正常; 1: 过高
	Bit 8	电池组 2 温度过高	0: 正常; 1: 过高
	Bit 9	电池组 1 接地故障	0: 正常; 1: 故障

ID	位	项目	值
1033	Bit 10	电池组 2 接地故障	0: 正常; 1: 故障
	Bit 11	主路频率异常	0: 正常; 1: 超限
	Bit 12	平衡电感过温	0: 正常; 1: 过温
	Bit 13	输入电感过温	0: 正常; 1: 过温
	Bit 14	整流器过温	0: 正常; 1: 过温
	Bit 15	平衡电路故障	0: 正常; 1: 故障
1034	Bit 0	平衡电路过流	0: 正常; 1: 过流
	Bit 1	主路熔断	0: 正常; 1: 断
	Bit 2	辅助电源 1 掉电	0: 正常; 1: 故障
	Bit 3	主路相序反	0: 正常; 1: 故障
	Bit 4	整流器过流	0: 正常; 1: 故障
	Bit 5	软启动失败	0: 正常; 1: 故障
	Bit 6	逆变电感过温	0: 正常; 1: 过温
	Bit 7	逆变器过温	0: 正常; 1: 过温
	Bit 8	逆变晶闸管故障	0: 正常; 1: 故障
	Bit 9	用户操作错误	0: 正常; 1: 错误
	Bit 10	输出熔断	0: 正常; 1: 断
	Bit 11	单机输出过载	0: 正常; 1: 过载
	Bit 12	并机系统过载	0: 正常; 1: 过载
	Bit 13	单机过载超时	0: 正常; 1: 过载超时
	Bit 14	交流输出过压	0: 正常; 1: 过压
	Bit 15	逆变器过流	0: 正常; 1: 过流
1035	Bit 0	负载冲击转旁路	0: 正常; 1: 故障
	Bit 1	并机均流故障	0: 正常; 1: 故障
	Bit 2	母线异常关机	0: 正常; 1: 故障
	Bit 3	邻机请求转旁路	0: 正常; 1: 故障
	Bit 4	直流母线过压故障	0: 正常; 1: 故障
	Bit 5	整流通讯故障	0: 正常; 1: 故障
	Bit 6	逆变通讯故障	0: 正常; 1: 故障
	Bits 7	输出直流分量过大故障	0: 正常; 1: 故障
	Bit 8	并机系统电池预告警故障	0: 正常; 1: 故障
	Bit 9	输入缺零故障	0: 正常; 1: 故障
	Bit 10	逆变接触器故障	0: 正常; 1: 故障
	Bit 11	输入接触器故障	0: 正常; 1: 故障
	Bit 12	输入电流异常	0: 正常; 1: 故障
	Bit 13	输出电压异常	0: 正常; 1: 故障
	Bit 14	输入电流超限	0: 正常; 1: 故障
	Bit 15	旁路过温	0: 正常; 1: 故障
1036	Bit 0	邻机晶闸管故障	0: 正常; 1: 故障
	Bit 1	外部输入隔离变压器过温	0: 正常; 1: 故障
	Bit 2	外部输入隔离变压器风扇故障	0: 正常; 1: 故障
	Bit 3	旁路柜变压器过温	0: 正常; 1: 故障
	Bit 4-15	未定义	

3. UPS 状态量

ID	位	项目	值
1040	Bits 1/0	供电方式	00: UPS 供电; 01: 旁路供电; 10: 均不供电
	Bit 2	电池组 1 电池自检	0: 自检; 1: 不在自检
	Bit 4/3	电池组 1 均充浮充	00: 浮充; 01: 均充; 10: 非充电状态
	Bit 5	整机开机/关机	0: 关机; 1: 开机
	Bit 7/6	整流器供电状态	00: 主路输入, 整流器开启 01: 电池输入, 整流器开启 10: 联合输入, 整流器开启 11: 主路、电池均无输入
	Bit 8	整机发电机接入事件	0: 发电机接入; 1: 发电机没接入
	Bit 9	整机输入空开状态	0: 断开状态; 1: 闭合状态
	Bit 10	整机维修旁路空开状态	0: 断开状态; 1: 闭合状态
	Bit 11	整机旁路空开状态	0: 断开状态; 1: 闭合状态
	Bit 12	整机输出空开状态	0: 断开状态; 1: 闭合状态
	Bits 15/14/13	整机旋转空开状态	000: 关闭状态 001: 测试状态 010: 正常状态 011: 旁路状态 100: 维修状态
1041	Bits 2/1/0	机架并机系统供电状态	000: 均不供电 001: 旁路供电 010: 市电供电 011: 电池逆变供电 100: 联合供电 101: 输出禁止
	Bit 3	电池组 2 电池自检	0: 自检中; 1: 没在自检
	Bits 5/4	电池组 2 浮充/均充状态	00: 浮充; 01: 均充; 10: 非充电状态
	Bit 6	模块 1 在线状态	0: 在线; 1: 不在线
	Bit 7	模块 2 在线状态	0: 在线; 1: 不在线
	Bit 8	模块 3 在线状态	0: 在线; 1: 不在线
	Bit 9	模块 4 在线状态	0: 在线; 1: 不在线
	Bit 10	模块 5 在线状态	0: 在线; 1: 不在线
	Bit 11	模块 6 在线状态	0: 在线; 1: 不在线
	Bit 12	模块 7 在线状态	0: 在线; 1: 不在线
	Bit 13	模块 8 在线状态	0: 在线; 1: 不在线
	Bit 14	模块 9 在线状态	0: 在线; 1: 不在线
	Bit 15	模块 10 在线状态	0: 在线; 1: 不在线

4. UPS 模拟量

ID	字节数	项目	值
1050	2	输入相电压 A	0.1V
1051	2	输入相电压 B	0.1V
1052	2	输入相电压 C	0.1V
1053	2	输出相电压 A	0.1V
1054	2	输出相电压 B	0.1V
1055	2	输出相电压 C	0.1V
1056	2	输出相电流 A	0.1A

ID	字节数	项目	值
1057	2	输出相电流 B	0.1A
1058	2	输出相电流 C	0.1A
1059	2	直流输入电压 (电池组 1 电压)	0.1V
1060	2	输出频率 (三相一致)	0.01Hz
1065	2	输入线电压 AB	0.1V
1066	2	输入线电压 BC	0.1V
1067	2	输入线电压 CA	0.1V
1068	2	输入相电流 A	0.1A
1069	2	输入相电流 B	0.1A
1070	2	输入相电流 C	0.1A
1071	2	输入频率 (三相一致)	0.01Hz
1072	2	A 相输入功率因数	0.01
1073	2	B 相输入功率因数	0.01
1074	2	C 相输入功率因数	0.01
1075	2	旁路相电压 A	0.1V
1076	2	旁路相电压 B	0.1V
1077	2	旁路相电压 C	0.1V
1078	2	旁路频率	0.01Hz
1079	2	A 相输出功率因数	0.01
1080	2	B 相输出功率因数	0.01
1081	2	C 相输出功率因数	0.01
1082	2	A 相输出峰值比	0.01
1083	2	B 相输出峰值比	0.01
1084	2	C 相输出峰值比	0.01
1085	2	A 相输出有功功率	0.01kW
1086	2	B 相输出有功功率	0.01kW
1087	2	C 相输出有功功率	0.01kW
1088	2	A 相输出无功功率	0.01kVA
1089	2	B 相输出无功功率	0.01kVA
1090	2	C 相输出无功功率	0.01kVA
1091	2	A 相输出视在功率	0.01kVA
1092	2	B 相输出视在功率	0.01kVA
1093	2	C 相输出视在功率	0.01kVA
1094	2	A 相输出负载百分比	0.01
1095	2	B 相输出负载百分比	0.01
1096	2	C 相输出负载百分比	0.01
1097	2	电池后备时间	Minute
1098	2	正电池电压	0.1V
1099	2	正电池电流	0.1A
1100	2	负电池电压	0.1V
1101	2	负电池电流	0.1A
1102	2	电池老化系数	0.1
1103	2	电池温度	0.1℃
1104	2	环境温度	0.1℃

5. SPM 告警量

ID	位	项目	值
2000	Bit 2/1/0	未定义	
	Bit 3	内部通信状态	0: 正常; 1: 告警
	Bit 4	输入干接点 1 状态	0: 正常; 1: 告警
	Bit 5	输入干接点 2 状态	0: 正常; 1: 告警
	Bit 6	输入干接点 3 状态	0: 正常; 1: 告警
	Bit 7	输入干接点 4 状态	0: 正常; 1: 告警
	Bit 8	采集板 5 就绪状态	0: 正常; 1: 告警
	Bit 9	采集板 6 就绪状态	0: 正常; 1: 告警
	Bits 10	采集板 7 就绪状态	0: 正常; 1: 告警
	Bit 11	采集板 8 就绪状态	0: 正常; 1: 告警
	Bit 12	采集板 10 就绪状态	0: 正常; 1: 告警
	Bit 13	采集板 11 就绪状态	0: 正常; 1: 告警
	Bit 14	采集板 12 就绪状态	0: 正常; 1: 告警
	Bit 15	CRC 校验状态	0: 正常; 1: 告警
2001+n (0≤N≤17)	Bit 0	支路 3n+1 电流过流	0: 正常; 1: 告警
	Bit 1	支路 3n+1 电流超高阈值	0: 正常; 1: 告警
	Bit 2	支路 3n+1 电流超低阈值	0: 正常; 1: 告警
	Bit 3	支路 3n+1 电流冲击过流	0: 正常; 1: 告警
	Bit 4	支路 3n+1 开关异常	0: 正常; 1: 告警
	Bit 5	支路 3n+2 电流过流	0: 正常; 1: 告警
	Bit 6	支路 3n+2 电流超高阈值	0: 正常; 1: 告警
	Bit 7	支路 3n+2 电流超低阈值	0: 正常; 1: 告警
	Bit 8	支路 3n+2 电流冲击过流	0: 正常; 1: 告警
	Bit 9	支路 3n+2 开关异常	0: 正常; 1: 告警
	Bit 10	支路 3n+3 电流过流	0: 正常; 1: 告警
	Bit 11	支路 3n+3 电流超高阈值	0: 正常; 1: 告警
	Bit 12	支路 3n+3 电流超低阈值	0: 正常; 1: 告警
	Bit 13	支路 3n+3 电流冲击过流	0: 正常; 1: 告警
Bit 14	支路 3n+3 开关异常	0: 正常; 1: 告警	

6. SPM 模拟量

ID	字节数	项目	值
1128	2	支路 1 电流	0.1A
1129	2	支路 1 电能	0.1kWh
1130	2	支路 1 开关状态	1
1131	2	支路 1 有功功率	0.1kW
1132	2	支路 1 视在功率	0.1kW
1133	2	支路 1THDi	0.01
1134	2	支路 1 额定电流	0.1A
1135	2	支路 1 负载率	0.01
1136	2	支路 1 功率因数	0.01
1137	2	支路 1 预留	
1138	2	支路 1 预留	
1139	2	支路 1 预留	
1140	2	支路 1 预留	
1141	2	支路 1 预留	
1142	2	支路 1 预留	

ID	字节数	项目	值
1143	2	支路 2 电流	0.1A
1144	2	支路 2 电能	0.1kWh
1145	2	支路 2 开关状态	1
1146	2	支路 2 有功功率	0.1kW
1147	2	支路 2 视在功率	0.1kW
1148	2	支路 2THDi	0.01
1149	2	支路 2 额定电流	0.1A
1150	2	支路 2 负载率	0.01
1151	2	支路 2 功率因数	0.01
1152	2	支路 2 预留	
1153	2	支路 2 预留	
1154	2	支路 2 预留	
1155	2	支路 2 预留	
1156	2	支路 2 预留	
1157	2	支路 2 预留	
.....
1923		支路 54 电流	0.1A
1924		支路 54 电能	0.1kWh
1925		支路 54 开关状态	1
1926		支路 54 有功功率	0.1kW
1927		支路 54 视在功率	0.1kW
1928		支路 54THDI	0.01
1929		支路 54 额定电流	0.1A
1930		支路 54 负载率	0.01
1931		支路 54 功率因数	0.01
1932		支路 54 预留	
1933		支路 54 预留	
1934		支路 54 预留	
1935		支路 54 预留	
1936		支路 54 预留	
1937		支路 54 预留	
.....
1999		支路预留	

第四章 常见问题及解决方法

1. 将适配卡插入 UPS or FLP 的 SNMP 卡插槽后，适配卡的黄灯（设备通讯指示灯）不亮。

原因和解决方法：UPS or FLP 已关机或未接入市电。请开启 UPS or FLP，如果无法开启 UPS or FLP，请将 UPS or FLP 接入市电后再试。

2. 适配卡安装完成后，适配卡的黄灯（设备通讯指示灯）常亮，且用户后台监控软件无法正常监控 UPS or FLP。

原因和解决方法：此时 UPS or FLP 已经上电开机，但是适配卡没有与 UPS or FLP 进行通讯。请拔出适配卡，检查板上是否有芯片，芯片是否插紧。否则可以认为该适配卡损坏，请联系艾默生当地用服中心。

3. 安装适配卡后，适配卡的黄灯（设备通讯指示灯）约 5 秒闪烁一次，且用户后台监控软件无法正常监控 UPS or FLP。

原因和解决方法：黄灯 5 秒闪烁一次，表示适配卡无法检测到 UPS or FLP，或者无法识别该 UPS or FLP 类别。出现这种情况，需要根据 1.3 节的硬件说明，检查适配卡是否支持这一 UPS or FLP 类别。适配卡能自动识别 UPS or FLP 类别，识别后黄灯快速闪烁（约 1 秒闪烁一次）。

4. 适配卡的黄灯（设备通讯状态指示灯）快速闪烁，绿灯（主机通讯状态指示灯）不亮。

原因和解决方法：适配卡没有正确接入用户后台监控主机。请参照 2.3.3 节提供的连接方法，正确连接适配卡与监控主机。

5. 适配卡的黄灯（设备通讯状态指示灯）快速闪烁，绿灯（主机通讯状态指示灯）也闪烁，但是用户后台监控软件无法正常监控 UPS or FLP。

原因和解决方法：黄灯快速闪烁说明适配卡与 UPS or FLP 的通讯正常；如绿灯闪烁，但是后台监控软件不能检测到 UPS or FLP 的信息，应检查：1) 适配卡与后台监控主机之间的通讯电缆是否可靠连接；2) 适配卡的物理地址和通讯波特率设置是否与后台监控软件中的物理地址和通讯波特率设置一致；3) 适配卡的物理地址设置是否与其它被监控对象的物理地址冲突（只适用于 RS485 级连方式）。

附录一 有毒有害物质或元素标识表

部件名称	有毒有害物质或元素					
	铅	汞	镉	六价铬	多溴联苯	多溴联苯醚
	Pb	Hg	Cd	Cr ⁶⁺	PBB	PBDE
制成板	×	○	○	○	○	○
<p>○：表示该有毒有害物质在该部件所有均质材料中的含量在 SJ/T-11363—2006 规定的限量要求以下</p> <p>×：表示该有毒有害物质至少在该部件的某一均质材料中的含量超出 SJ/T11363—2006 规定的限量要求</p> <p>艾默生网络能源有限公司一直致力于设计和制造环保的产品，我们会通过持续的研究来减少和消除产品中的有毒有害物质。以下部件或者应用中含有有毒有害物质是限于目前的技术水平无法实现可靠的替代或者没有成熟的解决方案：</p> <ol style="list-style-type: none"> 1. 焊料含有铅 2. 铜合金中含有铅 3. 电阻体玻璃含铅 						
适用范围：UF-MODBUS110, UF-MODBUS210, UF-MODBUS410						

Contents

Chapter 1 Product Description	1
1.1 Introduction	1
1.2 Specifications And Features	1
1.3 Appearance And Hardware Description	1
Chapter 2 Installation	3
2.1 Unpacking Inspection.....	3
2.2 Installation Notes	3
2.3 Installation Procedures	3
2.3.1 Setting Basic Parameters	3
2.3.2 Plugging In Adapter	5
2.3.3 Connecting Communication Cable	5
2.3.4 Setting Communication Parameters In Host Software.....	6
Chapter 3 Protocol Text	7
3.1 Protocol Text Of UL33 UPS	7
3.2 Protocol Text Of UH31 UPS	10
3.3 Protocol Text Of UH11 UPS	11
3.4 Protocol Text Of iTrust 2G UPS.....	12
3.5 Protocol Text Of iTrust Adapt 5/10kVA UPSs	14
3.6 Protocol Text Of NXa, NXb, NXe UPSs	16
3.7 Protocol Text Of Hipulse U UPS And FLP	19
3.8 Protocol Text Of NXr & iTrust Adapt 16/20kVA UPSs.....	22
3.9 Protocol Text Of APM 150 UPS	25
Chapter 4 Troubleshooting.....	31

Chapter 1 Product Description

1.1 Introduction

The UPS JBUS/MODBUS adapter (hereinafter referred to as “adapter”) allows you to use your host monitoring software to monitor your Emerson UPS and FLP field lighting power supply system (FLP for short) equipment through JBUS/MODBUS (RTU) protocol, to learn about the equipment operating status by acquiring the equipment electrical parameter data, operating data and alarm data.

Currently the adapter supports the UPS and FLP equipment listed in Table 1-1.

Table 1-1 UPS and FLP equipment supported by adapter

S/N.	Equipment	Equipment series
1	UL33 UPS	ITrust series
2	UH31 UPS	
3	UH11 UPS	
4	ITrust 2G UPS	
5	iTrust Adapt UPS 5/10/16/20kVA	
6	NXa UPS	NX series
7	NXb UPS	
8	NXe UPS	
9	Hipulse U UPS 120/160/200/300/400 kVA	Hipulse U series
10	FLP120/160/200/300/400 kVA	FLP series
11	NXr UPS	NXr series
12	APM 150 UPS	

1.2 Specifications And Features

- Protocol: JBUS/MODBUS (RTU);
- Communication mode: RS485, RS232;
- Setting range of physical address: 1~31;
- Setting range of communication baud rate: 2400, 4800, 9600 (default), 19200bps;
- Communication data format: 1 start bit, 8 data bit, 1 stop bit, no parity check;
- CRC16 standard check mode, first high byte, then low byte;
- Hot-pluggable, easy to install.

1.3 Appearance And Hardware Description

Appearance

The adapter is a plug-in card, and should be plugged in the SNMP slot of the UPS and FLP. The adapter is shown in Figure 1-1.

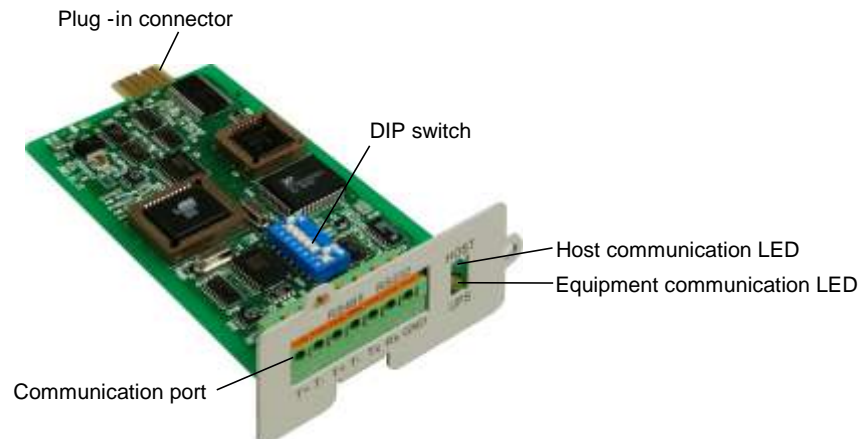

Figure 1-1 Adapter appearance

Hardware description

The printed board of the adapter is available in two sizes: 130mm (L) x60mm (W) x1.6mm (H) and 130mm (L) x63mm (W) x1.6mm (H); additionally, the former has a narrow opening at the plug-in connector. The former is applicable to NX, NXr series UPS, iTrust Adapt UPS and APM 150 UPS, while the latter is applicable to Hipulse U series UPS, FLP, and all iTrust series UPS except for iTrust Adapt UPS.

As shown in Figure 1-1, the adapter provides communication port, equipment communication LED, host communication LED, plug-in connector and DIP switch, which are described in Table 1-2.

Table 1-2 Hardware description

Name	Description
Communication port	Connects to the host computer, supports RS232 and RS485 communication modes
equipment communication LED (yellow)	OFF: power off
	ON: power on, but communication with UPS or FLP not established
	Flash slowly (once per 5s): communication with UPS or FLP failed
	Flash quickly (about once per 1s): communication with UPS or FLP is normal
Host communication LED (green)	OFF: communication with host computer not established
	Flash: communication with host computer being normal
Plug-in connector	Plug in the SNMP slot of the UPS or FLP, connect to the UPS or FLP
DIP switch	Used to configure the basic parameters of the adapter

Warning

All external ports of the adapter must connect to SELV circuit. Failure to observe this could cause damage to the adapter.

Chapter 2 Installation

2.1 Unpacking Inspection

Unpack the adapter, take out the delivery list (see Table 2-1), and check the goods against it. Should there be any discrepancy, contact the distributor immediately.

Table 2-1 Adapter delivery list

S/N.	Goods	Qty.	Remark
1	Adapter	1 pcs	
2	CD	1 pcs	UPS JBUS/MODBUS Adapter User Manual

2.2 Installation Notes

1. The adapter should be installed in the SNMP slot of the UPS or FLP, which is also used for the installation of SNMP card. Therefore, if you use the adapter, you cannot use the SNMP card.
2. The adapter is available in two sizes, please verify that your adapter matches the UPS or FLP (refer to the hardware description in section 1.3). Otherwise, the adapter cannot be plugged in the SNMP slot of the UPS or FLP.
3. Some electronic components of the adapter are sensitive to static electricity. To prevent static electricity from damaging the adapter, do not touch its electronic components or circuits, also avoid their contact with live objects. Therefore, please hold the side edges of the adapter when moving or installing it.

2.3 Installation Procedures

Please install the adapter in the following sequence:

1. Set the basic parameters of the adapter;
2. Plug the adapter in the SNMP slot;
3. Connect the communication cable;
4. Set the communication parameters in the host software.

2.3.1 Setting Basic Parameters

To enable the functions of the adapter, you must set its basic parameters, which are:

- Physical address
- Communication baud rate

These parameters are set by the 8-bit DIP switch of the adapter (refer to Figure 1-1 for its location). The up position means ON, the down position means OFF, as shown in the following figure.

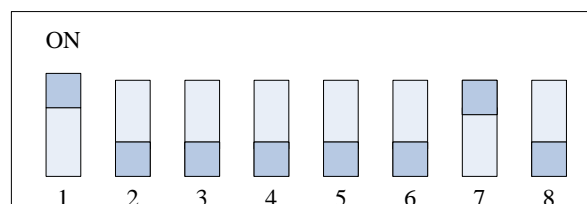

Figure 2-1 DIP switch

The basic parameters of the adapter are set by Bits 1~7 of the DIP switch, Bit 8 is factory reserved. The setting shown in Figure 2-1 is the factory default.

Setting physical address

The physical address of the adapter is set by Bits 1~5. The setting range is 1~31, 0 is factory-reserved setting, 1 is the factory default.

The physical address setting method is shown in Table 2-2:

Table 2-2 Physical address setting method

Physical address	Bit 1	Bit 2	Bit 3	Bit 4	Bit 5
0	OFF	OFF	OFF	OFF	OFF
1	ON	OFF	OFF	OFF	OFF
2	OFF	ON	OFF	OFF	OFF
3	ON	ON	OFF	OFF	OFF
4	OFF	OFF	ON	OFF	OFF
5	ON	OFF	ON	OFF	OFF
6	OFF	ON	ON	OFF	OFF
7	ON	ON	ON	OFF	OFF
8	OFF	OFF	OFF	ON	OFF
9	ON	OFF	OFF	ON	OFF
10	OFF	ON	OFF	ON	OFF
11	ON	ON	OFF	ON	OFF
12	OFF	OFF	ON	ON	OFF
13	ON	OFF	ON	ON	OFF
14	OFF	ON	ON	ON	OFF
15	ON	ON	ON	ON	OFF
16	OFF	OFF	OFF	OFF	ON
17	ON	OFF	OFF	OFF	ON
18	OFF	ON	OFF	OFF	ON
19	ON	ON	OFF	OFF	ON
20	OFF	OFF	ON	OFF	ON
21	ON	OFF	ON	OFF	ON
22	OFF	ON	ON	OFF	ON
23	ON	ON	ON	OFF	ON
24	OFF	OFF	OFF	ON	ON
25	ON	OFF	OFF	ON	ON
26	OFF	ON	OFF	ON	ON
27	ON	ON	OFF	ON	ON
28	OFF	OFF	ON	ON	ON
29	ON	OFF	ON	ON	ON
30	OFF	ON	ON	ON	ON
31	ON	ON	ON	ON	ON



Warning

The physical address 0 is factory reserved. You shall not set the physical address to 0; otherwise, the adapter cannot operate normally.

Setting communication baud rate

The communication baud rate of the adapter is set by Bits 6~7, and can be set to 2400bps, 4800bps, 9600bps, or 19200bps. 9600bps is the factory default.

The communication baud rate setting method is shown in Table 2-3:

Table 2-3 Communication baud rate setting method

Communication baud rate (bps)	Bit 6	Bit 7
2400	OFF	OFF
4800	ON	OFF
9600	OFF	ON
19200	ON	ON

2.3.2 Plugging In Adapter

Note

The adapter is hot-pluggable. You can install the adapter with shutting down the UPS or FLP.

User the following steps to plug the adapter in the SNMP slot of the UPS or FLP:

1. Remove the SNMP slot cover on the rear panel of the UPS or FLP.

Retain the SNMP slot cover and the screws for use in the future. Refer to the corresponding UPS or FLP user manual for the location of the SNMP slot.

2. Align the plug-in connector of the adapter with the SNMP slot, plug the adapter into the slot along the grooves on both sides of the slot, then fix the adapter through the fixing holes on the adapter panel.

More than ten seconds later, you will see the yellow equipment communication LED on the adapter panel flash quickly, indicating that the adapter has started to operate normally and the communication between the adapter and the UPS or FLP has been established.

2.3.3 Connecting Communication Cable

After plugging in and fixing the adapter, you need to connect the communication cable between the communication port of the adapter and the RS232 serial port of the computer.

Communication port of the adapter

The communication port of the adapter is shown in Figure 2-2.

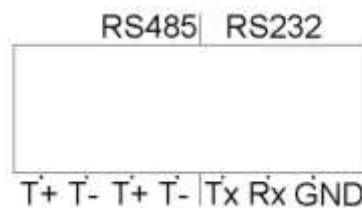

Figure 2-2 Communication port

As shown in the figure, the four terminals on the left are for RS485 communication, while the three ones on the right are for RS232 communication. The terminals are described in Table 2-4.

Table 2-4 Communication port terminal description

Terminal	Description
T+	RS485 communication differential signal+, 2 terminals, shorted internally, used for cascade connection
T-	RS485 communication differential signal -, 2 terminals, shorted internally, used for cascade connection
Tx	Transmit terminal of RS232 communication signal
Rx	Receive terminal of RS232 communication signal
GND	Signal ground

Connecting communication cable

There are two methods to make the communication connection between the adapter and the host computer.

1. RS232 communication

Make the connection between the adapter and the computer using the method shown in Table 2-5.

Table 2-5 Connection bet. adapter and computer (RS232)

Communication port of adapter	RS232 port of computer (DB9 male)
Tx	Pin 2
Rx	Pin 3
GND	Pin 5

2. RS485 communication

Where RS485 communication is used, please provide an RS232-to-RS485 converter for yourself, and make the connection between the adapter and the computer using the method shown in Table 2-6 and Table 2-7. For details of the communication ports of the RS232-to-RS485 converter, please refer to the user manual of the converter.

Table 2-6 Connection bet. adapter and RS232/RS485 converter (RS485)

Communication port of adapter	RS485 port of RS232-to-RS485 converter
T+	RS485 communication differential signal +
T-	RS485 communication differential signal -

Table 2-7 Connection bet. RS232/RS485 converter and computer (RS485)

RS232 port of RS232-to-RS485 converter	RS232 port of computer (DB9 male)
RS232 data transmission terminal	Pin 2
RS232 data receiving terminal	Pin 3
Signal ground	Pin 5

 **Warning**

RS232 communication and RS485 communication cannot be used at the same time.

2.3.4 Setting Communication Parameters In Host Software

After making communication connection, please start the host monitoring software and set the communication parameters. Note that the communication parameter settings in the host monitoring software should agree with the adapter's physical address and communication baud rate settings by the DIP switch. For the setting method, refer to the user manual of the host monitoring software.

After setting the communication parameters in the software, you will see the green host communication LED of the adapter flash, which indicates that the adapter is in normal operation and the communication between the software and the adapter has been established. At this point, you can view the UPS or FLP data through the software.

The installation of the adapter is complete.

Chapter 3 Protocol Text

The preconditions for the user's host monitoring software to monitor the UPS or FLP through the adapter is that the software supports JBUS/MODBUS (RTU) protocol and is able to interpret the JBUS/MODBUS (RTU) protocol text of the corresponding UPS or FLP.

Note

1. The adapter provides answer only to the #03 query command. It will not answer the query commands of other function codes.
2. When the adapter answers the #03 query command, it will return invalid data address information, with abnormal code #02, if the required byte of answer information is bigger than 100.
3. In communication through JBUS/MODBUS(RTU) protocol, the adapter is passive, waiting for the host monitoring software to query it.

The following sections provide the JBUS/MODBUS (RTU) protocol texts of various UPSs or FLPs.

3.1 Protocol Text Of UL33 UPS

1. UPS basic information

ID	Byte	Item	Value
1000~1004	10	UPS name	"UL33 0200L"
1005	2	UPS firmware release	0x010B corresponds to V1.11
1006~1015	20	Manufacturer	"EmersonNetworkPower "
1019	2	Adapter firmware release	0x010B corresponds to V1.11

2. UPS alarm data

ID	Bit	Item	Value
1030	Bit 0	UPS alarm flag	0: Normal; 1: Alarm
	Bit 1	Adapter communication failure flag	0: Normal; 1: Fault
	Bit 2	Not defined	
	Bit 3	Synchronization/Unsynchronization	0: Normal 1: Unsynchronization
	Bits 5/4	Mains voltage	00: Normal 01: Abnormal 10: Undervoltage
	Bit 6	Rectifier	0: Normal; 1: Fault
	Bit 7	Inverter	0: Normal; 1: Fault
	Bits 9/8	Bypass (voltage or frequency)	00: Normal 01: Outside synchronization range 10: Outside protection range
	Bits 12~10	Battery voltage status	000: Normal 001: No battery 010: Below lower limit (EOD point) 011: Above upper limit (voltage too high) 100: Battery reverse connection 101: Pre-alarm
Bits 15~13	Not defined		
1031	Bit 0	Battery test result	0: Normal; 1: need replacement
	Bit 1	Mains frequency	0: Normal; 1: Abnormal
	Bit 2	Input transformer overtemperature	0: Normal; 1: Overtemperature
	Bit 3	Output transformer overtemperature	0: Normal; 1: Overtemperature
	Bit 4	Inverter SCR damaged	0: Normal; 1: Abnormal
	Bit 5	Bypass SCR damaged	0: Normal; 1: Abnormal
	Bit 6	User operation error	0: Normal; 1: Abnormal

ID	Bit	Item	Value
1031	Bit 7	Inverter heatsink overtemperature	0: Normal; 1: Overtemperature
	Bit 8	Rectifier heatsink overtemperature	0: Normal; 1: Overtemperature
	Bit 9	Inverter fan failure	0: Normal; 1: Failed
	Bit 10	Rectifier fan fault	0: Normal; 1: Failed
	Bit 11	Battery contactor fault	0: Normal; 1: Abnormal
	Bit 12	Rectifier input contactor abnormal	0: Normal; 1: Abnormal
	Bit 13	Auxiliary contactor abnormal	0: Normal; 1: Abnormal
	Bit 14	Input fuse blowout	0: Normal; 1: Abnormal
	Bit 15	Output fuse blowout	0: Normal; 1: Abnormal
1032	Bit 0	Module output overload	0: Normal; 1: Overload
	Bit 1	Parallel system overload	0: Normal; 1: Overload
	Bit 2	Module overload timeout	0: Normal; 1: Overload timeout
	Bit 3	Bypass overcurrent timeout	0: Normal; 1: Overcurrent timeout
	Bit 4	Auxiliary supply 1 failure	0: Normal; 1: Fault
	Bit 5	Auxiliary supply 2 failure	0: Normal; 1: Fault
	Bit 6	UPS shutdown due to abnormal bypass	0: Normal; 1: Fault
	Bit 7	Bypass input phase rotation	0: Normal; 1: Fault
	Bit 8	Mains input phase rotation	0: Normal; 1: Fault
	Bit 9	Input soft start fault	0: Normal; 1: Fault
	Bit 10	AC output overvoltage	0: Normal; 1: Fault
	Bit 11	Output overcurrent impact	0: Normal; 1: Fault
	Bit 12	Inverter module overcurrent	0: Normal; 1: Fault
	Bit 13	Rectifier module overcurrent	0: Normal; 1: Fault
	Bits 15/14	Not defined	
1033	Bit 0	Transfer to bypass due to load impact	0: Normal; 1: Fault
	Bit 1	Transfer limitation	0: Normal; 1: Fault
	Bit 2	Parallel load sharing fault	0: Normal; 1: Fault
	Bit 3	Turn-off due to low bus voltage	0: Normal; 1: Fault
	Bit 4	Other module requests transfer to bypass	0: Normal; 1: Fault
	Bit 5	Ambient temperature too high	0: Normal; 1: Fault
	Bit 6	Ambient alarm channel 1 fault	0: Normal; 1: Fault
	Bit 7	Ambient alarm channel 2 fault	0: Normal; 1: Fault
	Bit 8	Ambient alarm channel 3 fault	0: Normal; 1: Fault
	Bit 9	Ambient alarm channel 4 fault	0: Normal; 1: Fault
	Bit 10	Ambient alarm channel 5 fault	0: Normal; 1: Fault
	Bit 11	Ambient alarm channel 6 fault	0: Normal; 1: Fault
	Bit 12	Ambient alarm channel 7 fault	0: Normal; 1: Fault
	Bit 13	Ambient alarm channel 8 fault	0: Normal; 1: Fault
	Bit 14	Rectifier communication fault	0: Normal; 1: Fault
	Bit 15	Inverter communication fault	0: Normal; 1: Fault
1034	Bit 0	Parallel board fault	0: Normal; 1: Fault
	Bit 1	DC bus overvoltage fault	0: Normal; 1: Fault
	Bits 15-2	Not defined	

3. UPS status data

ID	Bit	Item	Value
1040	Bits 2/1/0	Operation mode	000: Neither Normal nor Battery mode 001: Normal mode 010: Battery mode 011: Bypass mode 100: Source share mode
	Bit 3	Battery under test	0: Not under test; 1: Under test
	Bits 5/4	Boost/float charge	00: Float charge; 01: Boost charge; 10: Not charging
	Bit 6	Turn-on/off	0: Turn-on; 1: Turn-off
	Bit 7	Generator connection	0: Connected; 1: Not connected
	Bit 8	Input breaker state	0: Open; 1: Closed

ID	Bit	Item	Value
1040	Bit 9	Manual bypass breaker state	0: Open; 1: Closed
	Bit 10	Automatic bypass breaker state	0: Open; 1: Closed
	Bit 11	Output breaker state	0: Open; 1: Closed
	Bit 12	Generator operation status	0: Not in operation; 1: In operation
	Bit 13	Module output inhibited	0: Yes; 1: No
	Bit 14	Parallel system output inhibited	0: Yes; 1: No
	Bit 15	Not defined	
1041	Bits 2/1/0	UPS property	000: Single module 001: Master in hot standby 010: slave in hot standby 011: Master in parallel 100: Slave in parallel
	Bits 15~3	Not defined	

4. UPS analog data

ID	Byte	Item	Value
1050	2	AC input phase voltage A	2200 corresponds to 220.0Vac
1051	2	AC input phase voltage B	2200 corresponds to 220.0Vac
1052	2	AC input phase voltage C	2200 corresponds to 220.0Vac
1053	2	AC output phase voltage A	2200 corresponds to 220.0Vac
1054	2	AC output phase voltage B	2200 corresponds to 220.0Vac
1055	2	AC output phase voltage C	2200 corresponds to 220.0Vac
1056	2	AC output current A	1000 corresponds to 100.0A
1057	2	AC output current B	1000 corresponds to 100.0A
1058	2	AC output current C	1000 corresponds to 100.0A
1059	2	DC input voltage (battery voltage)	1000 corresponds to 100Vdc
1060	2	Output frequency (3 phases the same)	5000 corresponds to 50.00Hz
1061	2	AC input line voltage AB	3800 corresponds to 380.0Vac
1062	2	AC input line voltage BC	3800 corresponds to 380.0Vac
1063	2	AC input line voltage CA	3800 corresponds to 380.0Vac
1064	2	Phase A input current	1000 corresponds to 100.0A
1065	2	Phase B input current	1000 corresponds to 100.0A
1066	2	Phase C input current	1000 corresponds to 100.0A
1067	2	Input frequency (3 phases the same)	5000 corresponds to 50.00Hz
1068	2	Input power factor (3 phases the same)	100 corresponds to 1
1069	2	Phase A bypass voltage	2200 corresponds to 220.0Vac
1070	2	Phase B bypass voltage	2200 corresponds to 220.0Vac
1071	2	Phase C bypass voltage	2200 corresponds to 220.0Vac
1072	2	Phase A bypass current	1000 corresponds to 100.0A
1073	2	Phase B bypass current	1000 corresponds to 100.0A
1074	2	Phase C bypass current	1000 corresponds to 100.0A
1075	2	Bypass frequency (3 phases the same)	5000 corresponds to 50.00Hz
1076	2	Battery temperature	1000 corresponds to 100 Celsius degrees
1077	2	Phase A output power factor	100 corresponds to 1
1078	2	Phase B output power factor	100 corresponds to 1
1079	2	Phase C output power factor	100 corresponds to 1
1080	2	Phase A output active power	10000 corresponds to 100.00kW
1081	2	Phase B output active power	10000 corresponds to 100.00kW
1082	2	Phase C output active power	10000 corresponds to 100.00kW
1083	2	Battery current	1000 corresponds to 100.0A
1084	2	Battery autonomy	1 corresponds to 1 minute
1085	2	Phase A output apparent power	10000 corresponds to 100.00kVA
1086	2	Phase B output apparent power	10000 corresponds to 100.00kVA
1087	2	Phase C output apparent power	10000 corresponds to 100.00kVA
1088	2	Phase A output load percentage	1000 corresponds to 100.0%
1089	2	Phase B output load percentage	1000 corresponds to 100.0%
1090	2	Phase C output load percentage	1000 corresponds to 100.0%
1091	2	Ambient temperature	1000 corresponds to 100 Celsius degrees

ID	Byte	Item	Value
1092	2	Phase A output peak value	100 corresponds to 1
1093	2	Phase B output peak value	100 corresponds to 1
1094	2	Phase C output peak value	100 corresponds to 1

3.2 Protocol Text Of UH31 UPS

1. UPS basic information

ID	Byte	Item	Value
1000~1004	10	UPS name	"UH31 0200L"
1005	2	UPS firmware release	0x010B corresponds to V1.11
1006~1015	20	Manufacturer	"EmersonNetworkPower "
1019	2	Adapter firmware release	0x010B corresponds to V1.11

2. UPS alarm data

ID	Bit	Item	Value
1030	Bit 0	UPS alarm flag	0: Normal; 1: Alarm
	Bit 1	Adapter communication fault flag	0: Normal; 1: Fault
	Bit 2	Not defined	
	Bit 3	Synchronization/Unsynchronization	0: Normal; 1:Unsynchronization
	Bits 5/4	Mains voltage phase A	00: Normal 01: Below lower limit (mains failure) 10: Above upper limit 11: Outside specifications
	Bits 7/6	Mains voltage phase B	00: Normal 01: Below lower limit (mains failure) 10: Above upper limit 11: Outside specifications
	Bits 9/8	Mains voltage phase C	00: Normal 01: Below lower limit (mains failure) 10: Above upper limit 11: Outside specifications
	Bit 10	Rectifier	0: Normal; 1: Fault
	Bit 11	Inverter	0: Normal; 1: Fault
	Bits 13/12	Bypass voltage	00: Normal; 01: Below lower limit ; 10: Outside specifications
Bits 15~14	Not defined		
1031	Bit 2/1/0	Battery total voltage (+)	000: Normal 001: Below lower limit (EOD point) 010: Above upper limit (voltage too high) 011: Fault 100: Pre-alarm
	Bits 5/4/3	Battery total voltage (-)	000: Normal 001: Below lower limit (EOD point) 010: Above upper limit (voltage too high) 011: Fault 100: Pre-alarm
	Bit 6	Charger fault	0: Normal; 1: Fault
	Bit 7	Output shortcircuit	0: Normal; 1: Shortcircuit
	Bit 8	Output overload	0: Normal; 1: Overload
	Bit 9	Heatsink overtemperature	0: Normal; 1: Overtemperature
	Bit 10	Mains frequency	0: Normal; 1: Outside specifications
	Bit 11	Neutral line missing	0: Normal; 1: Fault
	Bit 12	Input phase missing	0: Normal; 1: Fault
Bits 15~13	Not defined		

3. UPS status data

ID	Bit	Item	Value
1040	Bit 1/0	Operation mode	00: Neither Normal nor Battery mode 01: Normal mode 10: Battery mode 11: Bypass mode
	Bit 2	Battery under test	0: Not under test; 1: Under test
	Bits 4/3	Boost/float charge (+)	00: Float charge; 01: Boost charge; 10: Not charging
	Bits 6/5	Boost/float charge (-)	00: Float charge; 01: Boost charge; 10: Not charging
	Bits 8/7	Turn-on/off	00: Turn-on; 01: Turn-off; 10: Is turning off
	Bits 15~9	Not defined	

4. UPS analog data

ID	Byte	Item	Value
1050	2	Phase A input voltage	2200 corresponds to 220.0Vac
1051	2	Phase B input voltage	2200 corresponds to 220.0Vac
1052	2	Phase C input voltage	2200 corresponds to 220.0Vac
1053	2	Bypass voltage	2200 corresponds to 220.0Vac
1054	2	Input frequency	5000 corresponds to 50.00Hz
1055	2	Output voltage	2200 corresponds to 220.0Vac
1056	2	Output current	1000 corresponds to 100.0A
1057	2	Output frequency	5000 corresponds to 50.00Hz
1058	2	Battery voltage (+)	1000 corresponds to 100Vdc
1059	2	Battery voltage (-)	1000 corresponds to 100Vdc
1060	2	Load percentage	1000 corresponds to 100.0%
1061	2	Battery capacity	1000 corresponds to 100.0%
1062	2	Internal temperature	1000 corresponds to 100 Celsius degrees

3.3 Protocol Text Of UH11 UPS

1. UPS basic information

ID	Byte	Item	Value
1000~1004	10	UPS name	"UH11 0100L"
1005	2	UPS firmware release	0x010B corresponds to V1.11
1006~1015	20	Manufacturer	"EmersonNetworkPower "
1019	2	Adapter firmware release	0x010B corresponds to V1.11

2. UPS alarm data

ID	Bit	Item	Value
1030	Bit 0	UPS alarm flag	0: Normal; 1: Alarm
	Bit 1	Adapter communication fault flag	0: Normal; 1: Fault
	Bit 2	Not defined	
	Bit 3	Synchronization/Unsynchronization	0: Normal; 1:Unsynchronization
	Bits 5/4	Mains voltage	00: Normal 01: Below lower limit (mains failure) 10: Above upper limit 11: Outside specifications
	Bit 6	Rectifier	0: Normal; 1: Fault
	Bit 7	Inverter	0: Normal; 1: Fault
	Bits 9/8	Bypass voltage	00: Normal; 01: Below lower limit; 10: Above upper limit

ID	Bit	Item	Value
1030	Bits 12/11/10	Battery total voltage	000: Normal 001: Below lower limit (EOD point) 010: Above upper limit (voltage too high) 011: Fault; 100: Pre-alarm
	Bit 13	Charger fault	0: Normal; 1: Fault
	Bit 14	Neutral/live line reversed	0: Normal; 1: Reversed
	Bit 15	Output shortcircuit	0: Normal; 1: Shortcircuit
1031	Bit 0	Output overload	0: Normal; 1: Overload
	Bit 1	Heatsink overtemperature	0: Normal; 1: Overtemperature
	Bit 2	Mains frequency	0: Normal; 1: Outside specifications
	Bits 15~3	Not defined	

3. UPS status data

ID	Bit	Item	Value
1040	Bits 1/0	Operation mode	00: Neither Normal nor Battery mode 01: Normal mode 10: Battery mode 11: Bypass mode
	Bit 2	Battery under test	0: Not under test; 1: Under test
	Bits 4/3	Boost/float charge	00: Float charge; 01: Boost charge; 10: Not charging
	Bits 6/5	Turn-on/off	00: Turn-on; 01: Turn-off 10: Is turning off
	Bits 15~7	Not defined	

4. UPS analog data

ID	Byte	Item	Value
1050	2	AC input phase voltage	2200 corresponds to 220.0Vac
1051	2	AC output phase voltage	2200 corresponds to 220.0Vac
1052	2	AC output current	1000 corresponds to 100.0A
1053	2	Battery voltage	1000 corresponds to 100Vdc
1054	2	Output frequency	5000 corresponds to 50.00Hz
1055	2	Input frequency	5000 corresponds to 50.00Hz
1056	2	Load percentage	1000 corresponds to 100.0%
1057	2	Battery capacity	1000 corresponds to 100.0%
1058	2	Internal temperature	1000 corresponds to 100 Celsius degrees

3.4 Protocol Text Of iTrust 2G UPS

1. UPS basic information

ID	Byte	Item	Value
1000~1004	10	UPS name	R/T UPS name: "UH11R0200L"
			Modular UPS name: "UP11 0200L"
1005	2	UPS firmware release	0x010B corresponds to V1.11
1006~1015	20	Manufacturer	"EmersonNetworkPower "
1019	2	Adapter firmware release	0x010B corresponds to V1.11

2. UPS alarm data

ID	Bit	Item	Value
1030	Bit 0	UPS alarm flag	0: Normal; 1: Alarm
	Bit 1	Adapter communication fault flag	0: Normal; 1: Fault
	Bit 2	Not defined	
	Bits 4/3	Mains voltage	00: Normal 01: Below lower limit 10: Above upper limit 11: Fault
	Bits 6/5	Bypass voltage	00: Normal 01: Below lower limit 10: Above upper limit 11: Fault
	Bit 7	Mains frequency	0: Normal; 1: Abnormal
	Bit 8	Bypass frequency	0: Normal; 1: Abnormal
	Bit 9	Charger module status	0: Normal; 1: Fault
	Bits 12/11/10	Battery status	000: Float charge 001: Fault 010: Battery low pre-alarm 011: Under test 100: Discharge 101: EOD 110: Boost charge 111: Not charging
	Bits 15/14/13	Module 1 status	000: Normal 001: Fault 010: Protection 011: Abnormal 100: Communication interrupt 101: Not known
1031	Bits 2/1/0	Module 2 status	000: Normal 001: Fault 010: Protection 011: Abnormal 100: Communication interrupt 101: Not known
	Bits 5/4/3	Module 3 status	000: Normal 001: Fault 010: Protection 011: Abnormal 100: Communication interrupt 101: Not known
	Bits 8/7/6	Module 4 status	000: Normal 001: Fault 010: Protection 011: Abnormal 100: Communication interrupt 101: Not known
	Bits 11/10/9	Module 5 status	000: Normal 001: Fault 010: Protection 011: Abnormal 100: Communication interrupt 101: Not known
	Bits 14/13/12	Module 6 status	000: Normal 001: Fault 010: Protection 011: Abnormal 100: Communication interrupt 101: Not known

ID	Bit	Item	Value
1031	Bit 15	Not defined	

3. UPS status data

ID	Bit	Item	Value
1040	Bits 1/0	Operation mode	00: Neither Normal nor Battery mode 01: Normal mode 10: Battery mode 11: Bypass mode
	Bit 2	ON or OFF state	0: ON ; 1: OFF
	Bit 3	Battery test enable	0: Yes; 1: No
	Bit 4	Overload transfer limitation enable	0: No; 1: Yes
	Bit 5	Redundancy	0: Enough1: Not enough
	Bits 15-6	Not defined	

4. UPS analog data

ID	Byte	Item	Value
1050	2	AC input phase voltage	22000 corresponds to 220.0Vac
1051	2	AC output phase voltage	22000 corresponds to 220.0Vac
1052	2	AC output current	10000 corresponds to 100.0A
1053	2	Output frequency	5000 corresponds to 50.00Hz
1054	2	AC input phase current	10000 corresponds to 100.0A
1055	2	Input power	10000 corresponds to 100.00kW
1056	2	Input frequency	5000 corresponds to 50.00Hz
1057	2	Output active power	10000 corresponds to 100.00kVA
1058	2	Output apparent power	10000 corresponds to 100.00kVA
1059	2	Battery autonomy	1000 corresponds to 1000min
1060	2	Battery voltage	22000 corresponds to 220.0V
1061	2	Bypass voltage	22000 corresponds to 220.0Vac
1062	2	Bypass current	10000 corresponds to 100.0A
1063	2	Bypass frequency	5000 corresponds to 50.00Hz
1064	2	Load percentage	10000 corresponds to 100.0%

3.5 Protocol Text Of iTrust Adapt 5/10kVA UPSs

1. UPS basic information

ID	Byte	Item	Value
1000~1004	10	UPS name UPS firmware release	R/T UPS name: "UHA1R0050L"
1005	2	Manufacturer	0x010B corresponds to V1.11
1006~1015	20	Adapter firmware release	"EmersonNetworkPower"
1019	2	UPS name	0x010B corresponds to V1.11

2. UPS alarm data

ID	Bit	Item	Value
1030	Bit 0	UPS alarm flag	0: Normal; 1: Alarm
	Bit 1	Adapter communication fault flag	0: Normal; 1: Fault
	Bit 2	Not defined	
	Bit 3	Synchronization/Unsynchronization	0: Normal; 1: Unsynchronization
	Bits 5/4	Mains status	00: Normal; 01: Abnormal
	Bit 6	Rectifier status	0: Normal; 1: Fault
	Bit 7	Inverter status	0: Normal; 1: Fault
	Bits 9/8	Bypass status	00: Normal; 01: Abnormal

ID	Bit	Item	Value
1030	Bits 11/10	Battery voltage status	00: Float charge 01: Below lower limit 10: Above upper limit 11: Fault
	Bit 12	Heatsink status	0: Normal; 1: Overtemperature
	Bit 13	Fan status	0: Normal; 1: Abnormal
	Bit 14	Neutral line missing	0: Normal; 1: Abnormal
	Bit 15	Bus voltage status	0: Normal; 1: Abnormal
1031	Bit 0	Charge module status	0: Normal; 1: Fault
	Bit 1	Battery EOD status	0: Normal; 1: Battery EOD
	Bit 2	Auxiliary supply status	0: Normal; 1: Fault
	Bit 3	Output overload status	0: Normal; 1: Overload
	Bit 4	Output shortcircuit status	0: Normal; 1: Shortcircuit
	Bit 5	Overload time-out	0: Normal; 1: Time-out
	Bit 6	Boost charge status	0: Normal; 1: Fault
	Bit 7	Parallel cable status	0: Normal; 1: Fault
	Bit 8	Parallel unit address conflict	0: Normal; 1: Fault
	Bit 9	Parallel unit communication status	0: Normal; 1: Failure
	Bits 15~10	Not defined	

3. UPS status data

ID	Bit	Item	Value
1040	Bits 1/0	Operation mode	00: Neither Normal nor Battery mode 01: Normal mode 10: Battery mode 11: Bypass mode
	Bits 3/2	Battery charge state	00: Float charge 01: Boost charge 10: Neither charge nor discharge 11: Discharge
	Bit 4	Battery self-test state	0: Not under test 1: Under test
	Bit 5	Battery self-test enable	0: Enabled 1: Not enabled
	Bit 6	Battery low pre-alarm	0: Battery voltage normal 1: Battery low pre-alarm
	Bit 7	Switch-on or switch-off	0: On; 1: Off
		Bits 15~8	Not defined

4. UPS analog data

ID	Byte	Item	Value
1050	2	AC input phase voltage A	22000 corresponds to 220.0Vac
1051	2	AC input phase voltage B	22000 corresponds to 220.0Vac
1052	2	AC input phase voltage C	22000 corresponds to 220.0Vac
1053	2	AC output phase voltage	22000 corresponds to 220.0Vac
1054	2	AC output current	10000 corresponds to 100.0A
1055	2	Battery voltage	22000 corresponds to 220.0Vdc
1056	2	Output frequency	5000 corresponds to 50.00Hz
1057	2	Input frequency	5000 corresponds to 50.00Hz
1058	2	Bypass voltage	22000 corresponds to 220.0Vac
1059	2	Bypass current	10000 corresponds to 100.0A
1060	2	AC output active power	10000 corresponds to 100.00kW
1061	2	AC output apparent power	10000 corresponds to 100.00kVA
1062	2	AC output load percentage	10000 corresponds to 100.0%

3.6 Protocol Text Of NXa, NXb, NXe UPSs

1. UPS basic information

ID	Byte	Item	Value
1000~1004	10	UPS name	"UH33 0200L"
1005	2	UPS firmware release	0x010B corresponds to V1.11
1006~1015	20	Manufacturer	"EmersonNetworkPower "
1019	2	Adapter firmware release	0x010B corresponds to V1.11

2. UPS alarm data

ID	Bit	Item	Value
1030	Bit 0	UPS alarm flag	0: Normal; 1: Alarm
	Bit 1	Adapter communication fault flag	0: Normal; 1: Fault
	Bit 2	Not defined	
	Bit 3	Synchronization/Unsynchronization	0: Normal 1: Unsynchronization
	Bit 4	Rectifier input voltage	0: Normal; 1: Abnormal
	Bit 5	Rectifier	0: Normal; 1: Fault
	Bit 6	Inverter	0: Normal; 1: Fault
	Bit 7	Bypass (voltage or frequency)	0: Normal 1: Outside specifications
	Bits 10/9/8	Battery total voltage	000: Normal 001: Below lower limit (EOD point) 010: Above upper limit (voltage too high) 011: No battery 100: Pre-alarm 101: Battery reverse connection
	Bit 11	Rectifier input frequency	0: Normal 1: Outside specifications
	Bit 12	Balanced inductor overtemperature	0: Normal; 1: Overtemperature
	1031	Bit 13	Input inductor overtemperature
Bit 14		Rectifier overtemperature	0: Normal; 1: Overtemperature
Bit 15		Balanced circuit fault	0: Normal; 1: Fault
Bit 0		Balanced circuit overcurrent	0: Normal; 1: Fault
Bit 1		Battery contactor fault	0: Normal; 1: Fault
Bit 2		Battery converter fault	0: Normal; 1: Fault
Bit 3		Battery converter overcurrent	0: Normal; 1: Overcurrent
Bit 4		Battery converter overtemperature	0: Normal; 1: Overtemperature
Bit 5		Rectifier input fuse	0: Normal; 1: Blown out
Bit 6		Auxiliary supply 1 failure	0: Normal; 1: Failed
Bit 7		Rectifier input phase rotation fault	0: Normal; 1: Fault
Bit 8		Rectifier overcurrent	0: Normal; 1: Fault
Bit 9		Soft start fault	0: Normal; 1: Fault
Bit 10		Bypass overcurrent fault	0: Normal; 1: Fault
Bit 11		Inverter inductor overtemperature	0: Normal; 1: Overtemperature
Bit 12		Inverter overtemperature	0: Normal; 1: Overtemperature
1032	Bit 13	Fan fault	0: Normal; 1: Fault
	Bit 14	Inverter SCR fault	0: Normal; 1: Fault
	Bit 15	Bypass SCR fault	0: Normal; 1: Fault
	Bit 0	User operation error	0: Normal; 1: Error
	Bit 1	Output fuse blowout	0: Normal; 1: Blown out
	Bit 2	Auxiliary supply 2 failure	0: Normal; 1: Failed
	Bit 3	Module output overload	0: Normal; 1: Overload
	Bit 4	Parallel system overload	0: Normal; 1: Overload
	Bit 5	Module overload timeout	0: Normal; 1: Overload timeout
	Bit 6	Shutdown due to abnormal bypass	0: Normal; 1: Abnormal
	Bit 7	AC output overvoltage	0: Normal; 1: Fault
	Bit 8	Inverter current	0: Normal; 1: Fault

ID	Bit	Item	Value
1032	Bit 9	Bypass phase rotation fault	0: Normal; 1: Fault
	Bit 10	Transfer to bypass due to load impact	0: Normal; 1: Fault
	Bit 11	Bypass transfer limitation	0: Normal; 1: Fault
	Bit 12	Parallel load sharing fault	0: Normal; 1: Fault
	Bit 13	Turnoff due to abnormal bus voltage	0: Normal; 1: Fault
	Bit 14	Other module requests transfer to bypass	0: Normal; 1: Fault
	Bit 15	Parallel board fault	0: Normal; 1: Fault
1033	Bit 0	DC bus overvoltage fault	0: Normal; 1: Fault
	Bit 1	Parallel cable connection fault	0: Normal; 1: Fault
	Bit 2	Ambient temperature too high	0: Normal; 1: Fault
	Bit 3	Rectifier communication fault	0: Normal; 1: Fault
	Bit 4	Inverter communication fault	0: Normal; 1: Fault
	Bit 5	Parallel communication fault	0: Normal; 1: Fault
	Bit 6	Output DC component too big fault	0: Normal; 1: Fault
	Bit 7	Parallel system battery pre-alarm fault	0: Normal; 1: Fault
	Bit 8	Input neutral line missing	0: Normal; 1: Fault
	Bit 9	Inverter contactor fault	0: Normal; 1: Fault
	Bit 10	Rectifier fault	0: Normal; 1: Fault
	Bits 12/11	Battery life	00: Normal 01: Battery needs replacement 10: Life span terminates
	Bit 13	EPO	0: Normal; 1: Fault
	Bit 14	Battery temperature too high	0: Normal; 1: Fault
Bit 15	Not defined		
1034	Bit 0	BCB status	00:BCB not connected 01:BCB closed 10:BCB open
	Bit 2	Battery earthing	0: Normal; 1: Fault
	Bits 15~3	Not defined	

3. UPS status data

ID	Bit	Item	Value
1040	Bits 2/1/0	Operation mode	000: Neither Normal nor Battery mode 001: Normal mode 010: Battery mode 011: Bypass mode 100: Source share mode
	Bit 3	Battery under test	0: Not under test; 1: Under test
	Bits 5/4	Boost/float charge	00: Float charge; 01: Boost charge 10: Not charging
	Bit 6	Turn-on/off	0: Turn-on; 1: Turn-off
	Bit 7	Generator connection	0: Connected 1: Not connected
	Bit 8	Input breaker state	0: Open; 1: Closed
	Bit 9	Maintenance bypass breaker state	0: Open; 1: Closed
	Bit 10	Bypass breaker state	0: Open; 1: Closed
	Bit 11	Output breaker state	0: Open; 1: Closed
	Bits 14/13/12	Bypass rotary switch state	000: Closed 001: Under test 010: Normal 011: Bypass state 100: Maintenance state
	Bit 15	Not defined	
1041	Bit 1/0	Parallel system operation mode	00: Normal mode 01: Battery mode 10: Bypass mode 11: No output
	Bits 15~2	Not defined	

4. UPS analog data

ID	Byte	Item	Value
1050	2	AC input phase voltageA	2200 corresponds to 220.0Vac
1051	2	AC input phase voltageB	2200 corresponds to 220.0Vac
1052	2	AC input phase voltageC	2200 corresponds to 220.0Vac
1053	2	AC output phase voltageA	2200 corresponds to 220.0Vac
1054	2	AC output phase voltageB	2200 corresponds to 220.0Vac
1055	2	AC output phase voltageC	2200 corresponds to 220.0Vac
1056	2	AC output current A	1000 corresponds to 100.0A
1057	2	AC output current B	1000 corresponds to 100.0A
1058	2	AC output current C	1000 corresponds to 100.0A
1059	2	Battery voltage	1000 corresponds to 100Vdc
1060	2	Output frequency (3 phases the same)	5000 corresponds to 50.00Hz
1061	2	AC input line voltage AB	3800 corresponds to 380.0Vac
1062	2	AC input line voltage BC	3800 corresponds to 380.0Vac
1063	2	AC input line voltage CA	3800 corresponds to 380.0Vac
1064	2	Phase A input current	1000 corresponds to 100.0A
1065	2	Phase B input current	1000 corresponds to 100.0A
1066	2	Phase C input current	1000 corresponds to 100.0A
1067	2	Input frequency (3 phases the same)	5000 corresponds to 50.00Hz
1068	2	Phase A input power factor	100 corresponds to 1
1069	2	Phase B input power factor	100 corresponds to 1
1070	2	Phase C input power factor	100 corresponds to 1
1071	2	Phase A bypass voltage	2200 corresponds to 220.0Vac
1072	2	Phase B bypass voltage	2200 corresponds to 220.0Vac
1073	2	Phase C bypass voltage	2200 corresponds to 220.0Vac
1074	2	Bypass frequency (3 phases the same)	5000 corresponds to 50.00Hz
1075	2	Battery current	1000 corresponds to 100.0A
1076	2	Phase A output power factor	100 corresponds to 1
1077	2	Phase B output power factor	100 corresponds to 1
1078	2	Phase C output power factor	100 corresponds to 1
1079	2	Module Phase A output peak value	100 corresponds to 1
1080	2	Module Phase B output peak value	100 corresponds to 1
1081	2	Module Phase C output peak value	100 corresponds to 1
1082	2	Module Phase A output active power	10000 corresponds to 100.00kW
1083	2	Module Phase B output active power	10000 corresponds to 100.00kW
1084	2	Module Phase C output active power	10000 corresponds to 100.00kW
1085	2	Module Phase A output apparent power	10000 corresponds to 100.00kVA
1086	2	Module Phase B output apparent power	10000 corresponds to 100.00kVA
1087	2	Module Phase C output apparent power	10000 corresponds to 100.00kVA
1088	2	Module Phase A output load percentage	1000 corresponds to 100.0%
1089	2	Module Phase B output load percentage	1000 corresponds to 100.0%
1090	2	Module Phase C output load percentage	1000 corresponds to 100.0%
1091	2	Module Phase A output reactive power	10000 corresponds to 100.00kVA
1092	2	ModulePhase B output reactive power	10000 corresponds to 100.00kVA
1093	2	ModulePhase C output reactive power	10000 corresponds to 100.00kVA
1094	2	System Phase A output active power	10000 corresponds to 100.00kW
1095	2	System Phase B output active power	10000 corresponds to 100.00kW
1096	2	System Phase C output active power	10000 corresponds to 100.00kW
1097	2	System Phase A output apparent power	10000 corresponds to 100.00kVA
1098	2	System Phase B output apparent power	10000 corresponds to 100.00kVA
1099	2	System Phase C output apparent power	10000 corresponds to 100.00kVA
1100	2	System Phase A output reactive power	10000 corresponds to 100.00kVA
1101	2	System Phase B output reactive power	10000 corresponds to 100.00kVA
1102	2	System Phase C output reactive power	10000 corresponds to 100.00kVA
1103	2	Battery autonomy	1 corresponds to 1 minute
1104	2	Battery temperature	1000 corresponds to 100 Celsius degrees
1105	2	Ambient temperature	1000 corresponds to 100 Celsius degrees
1106	2	Battery voltage (-)	1000 corresponds to 100Vdc

ID	Byte	Item	Value
1107	2	Battery current (-)	1000 corresponds to 100.0A

3.7 Protocol Text Of Hipulse U UPS And FLP

1. UPS basic information

ID	Byte	Item	Value
1000~1004	10	UPS name	"HL33 0200L"
1005	2	UPS firmware release	"0100" corresponds to V1.0
1006~1015	20	Manufacturer	"EmersonNetworkPower "
1019	2	Adapter firmware release	"0x1234" corresponds to Ver12.34

2. UPS alarm data

ID	Bit	Item	Value
1030	Bit 0	UPS alarm flag	0: Normal; 1: Alarm
	Bit 1	Adapter communication fault flag	0: Normal; 1: Fault
	Bit 2	Not defined	
	Bit 3	Synchronization/Unsynchronization	0: Normal 1: Unsynchronization
	Bit 4	Rectifier input voltage	0: Normal; 1: Abnormal
	Bit 5	Rectifier	0: Normal; 1: Fault
	Bit 6	Inverter	0: Normal; 1: Fault
	Bit 7	Bypass (voltage or frequency)	0: Normal 1: Outside specifications
	Bits 10/9/8	Battery total voltage	000: Normal 001: Below lower limit (EOD point) 010: Above upper limit (voltage too high) 011: No battery 100: Pre-alarm 101: Battery reverse connection
	Bit 11	Rectifier input frequency	0: Normal; 1: Outside specifications
	Bit 12	Input fuse	0: Normal; 1 Fail:
	Bit 13	Mains phase	0: Normal; 1: Reversed
	Bit 14	REC input Phase	0: Normal; 1: Missing
	Bit 15	Control power 1	0: Normal; 1: Fault
	1031	Bit 0	Control power 2
Bit 1		Rectifier	0: Normal; 1: Current limit
Bit 2		Soft start	0: Normal; 1: Fail
Bit 3		Rectifier overtemp.	0: Normal; 1: Overtemp.
Bit 4		Input filter fault	0: Normal; 1: Fault
Bit 5		Input filter transfer time-out	0: Normal; 1: Time-out
Bit 6		Filter contactor fault	0: Normal; 1: Fault
Bit 7		REC drive circuit fault	0: Normal; 1: Fault
Bit 8		Rectifier comm. fail	0: Normal; 1: Fail
Bit 9		Inverter overtemp.	0: Normal; 1: Overtemp.
Bit 10		Fan fault	0: Normal; 1: Fault
Bit 11		Inverter STS fail	0: Normal; 1: Fail
Bit 12		Bypass STS fail	0: Normal; 1: Fail
Bit 13		Operation invalid	0: Normal; 1: Invalid
Bit 14		Unit over load	0: Normal; 1: Over load
Bit 15	System over load	0: Normal; 1: Over load	
1032	Bit 0	Unit over load time-out	0: Normal; 1: Time-out
	Bit 1	By. abnormal shutdown	0: Normal; 1: Shutdown
	Bit 2	Output over voltage	0: Normal; 1: Over voltage
	Bit 3	Inverter over current	0: Normal; 1: Over current
	Bit 4	Bypass phase	0: Normal; 1: Reverse
	Bit 5	Load impact transfer	0: Normal; 1: Transfer

ID	Bit	Item	Value	
1032	Bit 6	Transfer time-out	0: Normal; 1: Time-out	
	Bit 7	Load sharing fault	0: Normal; 1: Fault	
	Bit 8	DC bus abnormal	0: Normal; 1: Abnormal	
	Bit 9	System transfer	0: Normal; 1: Transfer	
	Bit 10	Parallel board fault	0: Normal; 1: Fault	
	Bit 11	Parallel connect fault	0: Normal; 1: Fault	
	Bit 12	Parallel comm. fail	0: Normal; 1: Fault	
	Bit 13	Bypass over current	0: Normal; 1: Over current	
	Bits 15/14	LBS Active/Fault	00: Not Active 01: Active 10: Fault	
1033	Bit 0	Bypass induct overtemp.	0: Normal; 1: Overtemp	
	Bit 1	Static Sw. overtemp.	0: Normal; 1: Overtemp	
	Bit 2	Bypass feedback fault	0: Normal; 1: Fault	
	Bit 3	INV. drive circuit fault	0: Normal; 1: Fault	
	Bit 4	Inverter comm. fail	0: Normal; 1: Fault	
	Bit 5	System Battery low pre-warning	0: Normal; 1: Warning	
	Bit 6	EPO	0: Normal; 1: EPO	
	Bit 7	Ambient overtemp.	0: Normal; 1: Overtemp.	
		Bits 9/8	Battery life	00: Normal 01: Battery needs replacement 10: Life span terminates
		Bit 10	Battery overtemp.	0: Normal; 1: Overtemp.
	Bit 11	Battery ground fault	0: Normal; 1: Fault	
	Bit 12	Battery fuse fail	0: Normal; 1: Fault	
	Bits 14/13	BCB status	00: BCB not connected 01: BCB closed 10: BCB open	
	Bit 15	Output fuse fail (no use)	0: Normal; 1: Fault	
1034	Bit 0	Bus capacitor over voltage	0: Normal; 1: Fault	
	Bit 1	DC bus over voltage	0: Normal; 1: Fault	
	Bits 15~2	Not use		

3. UPS status data

ID	Bit	Item	Value
1040	Bits 2/1/0	Operation mode	000: Neither Normal nor Battery mode 001: Normal mode 010: Battery mode 011: Bypass mode 100: Source share mode
	Bit 3	Battery selftest	0: Not under test 1: Under test
	Bits 5/4	Boost/float charge	00: Float charge 01: Boost charge 10: Not charging
	Bit 6	Turn-on/off	0: Turn-on; 1: Turn-off
	Bit 7	Generator connection	0: Connected 1: Not connected
	Bit 8	Input breaker state	0: Open; 1: Closed
	Bit 9	Maintenance bypass breaker state	0: Open; 1: Closed
	Bit 10	Bypass breaker state	0: Open; 1: Closed
	Bit 11	Output breaker state	0: Open; 1: Closed
		Bits 13/12	Parallel system operation mode
	Bits 15/14	No use	

ID	Bit	Item	Value
1041	Bits 2/1/0	Bypass rotary switch state	000: Closed 001: Under test 010: Normal 011: Bypass state 100: Maintenance state
	Bits 15~3	No use	

4. UPS analog data

ID	Byte	Item	Value
1050	2	AC output phase voltage A	2200 corresponds to 220.0Vac
1051	2	AC output phase voltage B	2200 corresponds to 220.0Vac
1052	2	AC output phase voltage C	2200 corresponds to 220.0Vac
1053	2	AC output current A	1000 corresponds to 100.0A
1054	2	AC output current B	1000 corresponds to 100.0A
1055	2	AC output current C	1000 corresponds to 100.0A
1056	2	Battery voltage	1000 corresponds to 100Vdc
1057	2	Output frequency (3 phases the same)	5000 corresponds to 50.00Hz
1058	2	AC input line voltage AB	3800 corresponds to 380.0Vac
1059	2	AC input line voltage BC	3800 corresponds to 380.0Vac
1060	2	AC input line voltage CA	3800 corresponds to 380.0Vac
1061	2	Phase A input current	1000 corresponds to 100.0A
1062	2	Phase B input current	1000 corresponds to 100.0A
1063	2	Phase C input current	1000 corresponds to 100.0A
1064	2	Input frequency (3 phases the same)	5000 corresponds to 50.00Hz
1065	2	Total input power factor	100 corresponds to 1
1066	2	Phase A bypass voltage	2200 corresponds to 220.0Vac
1067	2	Phase B bypass voltage	2200 corresponds to 220.0Vac
1068	2	Phase C bypass voltage	2200 corresponds to 220.0Vac
1069	2	Bypass frequency (3 phases the same)	5000 corresponds to 50.00Hz
1070	2	Battery current	1000 corresponds to 100.0A
1071	2	Phase A output power factor	100 corresponds to 1
1072	2	Phase B output power factor	100 corresponds to 1
1073	2	Phase C output power factor	100 corresponds to 1
1074	2	Module Phase A output peak value	100 corresponds to 1
1075	2	Module Phase B output peak value	100 corresponds to 1
1076	2	Module Phase C output peak value	100 corresponds to 1
1077	2	Module Phase A output active power	10000 corresponds to 100.00kW
1078	2	Module Phase B output active power	10000 corresponds to 100.00kW
1079	2	Module Phase C output active power	10000 corresponds to 100.00kW
1080	2	Module Phase A output apparent power	10000 corresponds to 100.00kVA
1081	2	Module Phase B output apparent power	10000 corresponds to 100.00kVA
1082	2	Module Phase C output apparent power	10000 corresponds to 100.00kVA
1083	2	Module Phase A output load percentage	1000 corresponds to 100.0%
1084	2	Module Phase B output load percentage	1000 corresponds to 100.0%
1085	2	Module Phase C output load percentage	1000 corresponds to 100.0%
1086	2	Module Phase A output reactive power	10000 corresponds to 100.00kVA
1087	2	ModulePhase B output reactive power	10000 corresponds to 100.00kVA
1088	2	ModulePhase C output reactive power	10000 corresponds to 100.00kVA
1089	2	System Phase A output active power	10000 corresponds to 100.00kW
1090	2	System Phase B output active power	10000 corresponds to 100.00kW
1091	2	System Phase C output active power	10000 corresponds to 100.00kW
1092	2	System Phase A output apparent power	10000 corresponds to 100.00kVA
1093	2	System Phase B output apparent power	10000 corresponds to 100.00kVA
1094	2	System Phase C output apparent power	10000 corresponds to 100.00kVA
1095	2	System Phase A output reactive power	10000 corresponds to 100.00kVA
1096	2	System Phase B output reactive power	10000 corresponds to 100.00kVA
1097	2	System Phase C output reqctive power	10000 corresponds to 100.00kVA
1098	2	Battery autonomy	1 corresponds to 1 minute

ID	Byte	Item	Value
1099	2	Battery temperature	1000 corresponds to 100 Celsius degrees
1100	2	Ambient temperature	1000 corresponds to 100 Celsius degrees
1101	2	Battery aging ratio	10000 corresponds to 100

3.8 Protocol Text Of NXr & iTrust Adapt 16/20kVA UPSs

1. UPS basic information

ID	Byte	Item	Value
1000 ~ 1004	10	UPS name	"HR331500"
1005	2	UPS firmware release	0x0201 to V2.01
1006 ~ 1015	20	Manufacturer	"EmersonNetworkPower"
1019	2	Adapter firmware release	0x0201 to V2.01

2. UPS alarm data

ID	Bit	Item	Value
1030	Bit 0	UPS general alarm flag bit	0: Normal; 1: Alarm
	Bit 1	Modbus card/dry contactor card communication failure flag bit	0: Normal; 1: Failure
	Bit 2	Reserved	
	Bit 3	Inverter synchronous/asynchronous	0: Synchronous; 1: Asynchronous
	Bit 4	Mains voltage	0: Synchronous; 1: Asynchronous
	Bit 5	Rectifier status	0: Normal; 1: Failure
	Bit 6	Inverter status	0: Normal; 1: Failure
	Bit 7	Bypass conditions (voltage or frequency)	0: Normal; 1: Excessive
	Bits 10/9/8	Battery 1 status	000: Normal 001: Below the lower limit (power-off point) 010: Above the upper limit (excessive voltage) 011: No battery 100: Pre-alarm 101: Reverse batteries
	Bit 11	Functional module 1 failure	0: Normal; 1: Abnormal
	Bit 12	Functional module 2 failure	0: Normal; 1: Abnormal
1031	Bit 13	Functional module 3 failure	0: Normal; 1: Abnormal
	Bit 14	Functional module 4 failure	0: Normal; 1: Abnormal
	Bit 15	Functional module 5 failure	0: Normal; 1: Abnormal
	Bit 0	Functional module 6 failure	0: Normal; 1: Abnormal
	Bit 1	Functional module 7 failure	0: Normal; 1: Abnormal
	Bit 2	Functional module 8 failure	0: Normal; 1: Abnormal
	Bit 3	Functional module 9 failure	0: Normal; 1: Abnormal
	Bit 4	Functional module 10 failure	0: Normal; 1: Abnormal
	Bit 5	LBS abnormal	0: Normal; 1: Abnormal
	Bit 7/6	Keyboard failure or model capacity invalid	00: Normal; 01: Keyboard failure 10: Model capacity invalid
	Bit 8	Fan failure	0: Normal; 1: Failure
Bit 9	Environmental temperature over-high	0: Normal; 1: Over-high	
Bit 10	Emergency power off	0: Normal; 1: Power off	
Bit 11	Bypass thyristor failure	0: Normal; 1: Failure	
Bit 12	Bypass phase sequence reverse	0: Normal; 1: Failure	
Bit 13	Bypass over-current failure	0: Normal; 1: Failure	
Bit 14	Bypass abnormal power off	0: Normal; 1: Abnormal	
Bit 15	Bypass switching number limit	0: Normal; 1: Failure	
1032	Bit 0	Failure of module combining board	0: Normal; 1: Failure
	Bit 1	Failure of module combining cable	0: Normal; 1: Failure
	Bit 2	Communication failure of module combining	0: Normal; 1: Failure
	Bit 3	Auxiliary power 2 power off	0: Normal; 1: Failure
	Bit 4	Contactor power board 1 failure	0: Normal; 1: Failure
	Bit 5	Contactor power board 2 failure	0: Normal; 1: Failure

ID	Bit	Item	Value
1032	Bit 6	Redundant fan power failure	0: Normal; 1: Abnormal
	Bit 8/7	BCB access status	00: BCB not accessed; 01: BCB closed 03: BCB disconnected
	Bit 9	Battery 1 contactor failure	0: Normal; 1: Failure
	Bit 10	Battery 2 contactor failure	0: Normal; 1: Failure
	Bit 11	Battery 1 converter failure	0: Normal; 1: Failure
	Bit 12	Battery 2 converter failure	0: Normal; 1: Failure
	Bit 13	Battery 1 converter over-current	0: Normal; 1: Over-current
	Bit 14	Battery 2 converter over-current	0: Normal; 1: Over-current
	Bit 15	Battery 1 converter over-temperature	0: Normal; 1: Over-temperature
1033	Bit 0	Battery 2 converter over-temperature	0: Normal; 1: Over-temperature
	Bit 1	Battery 1 charger failure	0: Normal; 1: Failure
	Bit 2	Battery 2 charger failure	0: Normal; 1: Failure
	Bit 4/3	Battery 1 life	00: Normal; 01: Battery to be replaced 10: Battery life ended
	Bit 6/5	Battery 2 life	00: Normal; 01: Battery to be replaced 10: Battery life ended
	Bit 7	Battery 1 temperature over-high	0: Normal; 1: Over-high
	Bit 8	Battery 1 temperature over-high	0: Normal; 1: Over-high
	Bit 9	Battery 1 grounding failure	0: Normal; 1: Failure
	Bit 10	Battery 1 grounding failure	0: Normal; 1: Failure
	Bit 11	Master channel frequency abnormal	0: Normal; 1: Excessive
	Bit 12	Balance inductor over-temperature	0: Normal; 1: Over-temperature
	Bit 13	Input inductor over-temperature	0: Normal; 1: Over-temperature
	Bit 14	Rectifier over-temperature	0: Normal; 1: Over-temperature
	Bit 15	Balance circuit failure	0: Normal; 1: Failure
	1034	Bit 0	Balance inductor over-current
Bit 1		Master fuse broken	0: Normal; 1: Broken
Bit 2		Auxiliary power 1 power-off	0: Normal; 1: Failure
Bit 3		Master channel phase sequence reverse	0: Normal; 1: Failure
Bit 4		Rectifier over-current	0: Normal; 1: Failure
Bit 5		Software start failure	0: Normal; 1: Failure
Bit 6		Inversion inductor over-temperature	0: Normal; 1: Over-temperature
Bit 7		Inductor ove-temperature	0: Normal; 1: Over-temperature
Bit 8		Inversion thyristor failure	0: Normal; 1: Failure
Bit 9		User operation error	0: Normal; 1: Error
Bit 10		Output fuse broken	0: Normal; 1: Broken
Bit 11		Single unit output overload	0: Normal; 1: Overload
Bit 12		Combined system overload	0: Normal; 1: Overload
Bit13		Single unit overload timeout	0: Normal; 1: Overload timeout
Bit 14		AC output over-voltage	0: Normal; 1: Over-voltage
Bit 15	Inverter over-current	0: Normal; 1: Over-current	
1035	Bit 0	Turning to bypass due to load impact	0: Normal; 1: Failure
	Bit 1	Failure of current sharing in combined units	0: Normal; 1: Failure
	Bit 2	Abnormal power-off of bus	0: Normal; 1: Failure
	Bit 3	Turning to bypass due to request by neighbor system	0: Normal; 1: Failure
	Bit 4	DC bus over-voltage failure	0: Normal; 1: Failure
	Bit 5	Rectifier communication failure	0: Normal; 1: Failure
	Bit 6	Inverter communication failure	0: Normal; 1: Failure
	Bit 7	Output DC excess failure	0: Normal; 1: Failure
	Bit 8	Combined system battery pre-alarm failure	0: Normal; 1: Failure
	Bit 9	Input zero-lacking failure	0: Normal; 1: Failure
	Bit 10	Inversion contactor failure	0: Normal; 1: Failure
	Bit 11	Input contactor failure	0: Normal; 1: Failure
	Bit 12	Input current abnormal	0: Normal; 1: Failure
	Bit13	Output voltage abnormal	0: Normal; 1: Failure
	Bit 14	Input current excessive	0: Normal; 1: Failure
Bit 15	Bypass over-temperature	0: Normal; 1: Failure	

ID	Bit	Item	Value
1036	Bit 0	Thyristor failure in neighboring unit	0: Normal; 1: Failure
	Bit 1~15	Reserved	

3. UPS status data

ID	Bit	Item	Value
1040	Bit 1/0	Power supply mode	00: UPS power supply; 01: Bypass power supply 10: No power supply
	Bit 2	Battery 1 self-check	0: In self-check; 1: Not in self-check
	Bit 4/3	Battery 1 average charge/floating charge	00: Floating charge; 01: Average charge 10: Non-charging status
	Bit 5	Integrated equipment power-on/off	0: Power-off; 1: Power-on
	Bit 7/6	Rectifier power supply status	00: Master channel input, rectifier started 01: Battery input, rectifier started 10: Combined input, rectifier started 11: No input from master channel or batteries
	Bit 8	Integrated generator access event	0: Generator accessed; 1: Generator not accessed
	Bit 9	Integrated equipment input air breaker status	0: Disconnected; 1: Closed
	Bit 10	Integrated equipment maintenance bypass air breaker status	0: Disconnected; 1: Closed
	Bit 11	Integrated equipment bypass air breaker status	0: Disconnected; 1: Closed
	Bit 12	Integrated equipment output air breaker status	0: Disconnected; 1: Closed
	Bit 15/14/13	Integrated equipment revolving air breaker status	000: Closed 001: Under test 010: Normal 011: Bypass 100: Maintenance
1041	Bits 2/1/0	Rack combined system power supply status	000: No power supply 001: Bypass power supply 010: Mains supply 011: Battery inversion power supply 100: United power supply 101: Output prohibited
	Bit 3	Battery 2 battery self-check	0: in self-check; 1: Not in self-check
	Bit 5/4	Battery 2 floating / average charge status	00: Floating charge; 01: Average charge 10: Non charge
	Bit 6	Module 1 online or offline	0: Online; 1: Offline
	Bit 7	Module 2 online or offline	0: Online; 1: Offline
	Bit 8	Module 3 online or offline	0: Online; 1: Offline
	Bit 9	Module 4 online or offline	0: Online; 1: Offline
	Bit 10	Module 5 online or offline	0: Online; 1: Offline
	Bit 11	Module 6 online or offline	0: Online; 1: Offline
	Bit 12	Module 7 online or offline	0: Online; 1: Offline
	Bit 13	Module 8 online or offline	0: Online; 1: Offline
	Bit 14	Module 9 online or offline	0: Online; 1: Offline
	Bit 15	Module 10 online or offline	0: Online; 1: Offline

4. UPS analog data

ID	Byte	Item	Value
1050	2	Input phase voltage A	0.1V
1051	2	Input phase voltage B	0.1V
1052	2	Input phase voltage C	0.1V
1053	2	Output phase voltage A	0.1V
1054	2	Output phase voltage B	0.1V
1055	2	Output phase voltage C	0.1V
1056	2	Output phase current A	0.1A
1057	2	Output phase current B	0.1A
1058	2	Output phase current C	0.1A

ID	Byte	Item	Value
1059	2	DC input voltage (Battery 1 voltage)	0.1V
1060	2	Output frequency (consistency in three phases)	0.01Hz
1061	2	Input cable voltage AB	0.1V
1062	2	Input cable voltage BC	0.1V
1063	2	Input cable voltage CA	0.1V
1064	2	Input phase current A	0.1A
1065	2	Input phase current B	0.1A
1066	2	Input phase current C	0.1A
1067	2	Input frequency (consistency in three phases)	0.01Hz
1068	2	Phase A input power factor	0.01
1069	2	Phase B input power factor	0.01
1070	2	Phase C input power factor	0.01
1071	2	Bypass phase voltage A	0.1V
1072	2	Bypass phase voltage B	0.1V
1073	2	Bypass phase voltage C	0.1V
1074	2	Bypass frequency	0.01Hz
1075	2	Phase A output power factor	0.01
1076	2	Phase B output power factor	0.01
1077	2	Phase C output power factor	0.01
1078	2	Phase A output peak ratio	0.01
1079	2	Phase B output peak ratio	0.01
1080	2	Phase C output peak ratio	0.01
1081	2	Phase A output active power	0.01kW
1082	2	Phase B output active power	0.01kW
1083	2	Phase C output active power	0.01kW
1084	2	Phase A output reactive power	0.01kVA
1085	2	Phase B output reactive power	0.01kVA
1086	2	Phase C output reactive power	0.01kVA
1087	2	Phase A output apparent power	0.01kVA
1088	2	Phase B output apparent power	0.01kVA
1089	2	Phase C output apparent power	0.01kVA
1090	2	Battery backup time	Minute
1091	2	Positive battery voltage	0.1V
1092	2	Positive battery current	0.1A
1093	2	Negative battery voltage	0.1V
1094	2	Negative battery current	0.1A
1095	2	Battery aging coefficient	0.1
1096	2	Battery temperature	0.1°C
1097	2	Environmental temperature	0.1°C

3.9 Protocol Text Of APM 150 UPS

1. UPS basic information

ID	Byte	Item	Value
1000 ~ 1004	10	UPS name	"APM 150"
1005	2	UPS firmware release	0x0210 to V2.10
1006 ~ 1015	20	Manufacturer	"EmersonNetworkPower"
1016	6	UPS extension name	Reserved
1019	2	Adapter firmware release	0x0210 to V2.10

2. UPS alarm data

ID	Bit	Item	Value
1030	Bit 0	UPS general alarm flag bit	0: Normal; 1: Alarm
	Bit 1	Modbus card/dry contactor card communication failure flag bit	0: Normal; 1: Failure
	Bit 2	Reserved	
	Bit 3	Inverter synchronous/asynchronous	0: Synchronous; 1: Asynchronous

ID	Bit	Item	Value
1030	Bit 4	Mains voltage	0: Synchronous; 1: Asynchronous
	Bit 5	Rectifier status	0: Normal; 1: Failure
	Bit 6	Inverter status	0: Normal; 1: Failure
	Bit 7	Bypass conditions (voltage or frequency)	0: Normal; 1: Excessive
	Bits 10/9/8	Battery 1 status	000: Normal 001: Below the lower limit (power-off point) 010: Above the upper limit (excessive voltage) 011: No battery 100: Pre-alarm 101: Reverse batteries
	Bit 11	Functional module 1 failure	0: Normal; 1: Abnormal
	Bit 12	Functional module 2 failure	0: Normal; 1: Abnormal
	Bit 13	Functional module 3 failure	0: Normal; 1: Abnormal
	Bit 14	Functional module 4 failure	0: Normal; 1: Abnormal
1031	Bit 15	Functional module 5 failure	0: Normal; 1: Abnormal
	Bit 0	Functional module 6 failure	0: Normal; 1: Abnormal
	Bit 1	Functional module 7 failure	0: Normal; 1: Abnormal
	Bit 2	Functional module 8 failure	0: Normal; 1: Abnormal
	Bit 3	Functional module 9 failure	0: Normal; 1: Abnormal
	Bit 4	Functional module 10 failure	0: Normal; 1: Abnormal
	Bit 5	LBS abnormal	0: Normal; 1: Abnormal
	Bits 7/6	Keyboard failure or model capacity invalid	00: Normal 01: Keyboard failure 10: Model capacity invalid
	Bit 8	Fan failure	0: Normal; 1: Failure
	Bit 9	Environmental temperature over-high	0: Normal; 1: Over-high
	Bit 10	Emergency power off	0: Normal; 1: Power off
	Bit 11	Bypass thyristor failure	0: Normal; 1: Failure
	Bit 12	Bypass phase sequence reverse	0: Normal; 1: Failure
	Bit 13	Bypass over-current failure	0: Normal; 1: Failure
	Bit 14	Bypass abnormal power off	0: Normal; 1: Abnormal
1032	Bit 15	Bypass switching number limit	0: Normal; 1: Failure
	Bit 0	Failure of module combining board	0: Normal; 1: Failure
	Bit 1	Failure of module combining cable	0: Normal; 1: Failure
	Bit 2	Communication failure of module combining	0: Normal; 1: Failure
	Bit 3	Auxiliary power 2 power off	0: Normal; 1: Failure
	Bit 4	Contactor power board 1 failure	0: Normal; 1: Failure
	Bit 5	Contactor power board 2 failure	0: Normal; 1: Failure
	Bit 6	Redundant fan power failure	0: Normal; 1: Abnormal
	Bits 8/7	BCB access status	00: BCB not accessed 01: BCB closed 03: BCB disconnected
	Bit 9	Battery 1 contactor failure	0: Normal; 1: Failure
	Bit 10	Battery 2 contactor failure	0: Normal; 1: Failure
	Bit 11	Battery 1 converter failure	0: Normal; 1: Failure
	Bit 12	Battery 2 converter failure	0: Normal; 1: Failure
	Bit 13	Battery 1 converter over-current	0: Normal; 1: Over-current
	Bit 14	Battery 2 converter over-current	0: Normal; 1: Over-current
Bit 15	Battery 1 converter over-temperature	0: Normal; 1: Over-temperature	
1033	Bit 0	Battery 2 converter over-temperature	0: Normal; 1: Over-temperature
	Bit 1	Battery 1 charger failure	0: Normal; 1: Failure
	Bit 2	Battery 2 charger failure	0: Normal; 1: Failure
	Bits 4/3	Battery 1 life	00: Normal 01: Battery to be replaced 10: Battery life ended
	Bits 6/5	Battery 2 life	00: Normal 01: Battery to be replaced 10: Battery life ended
	Bit 7	Battery 1 temperature over-high	0: Normal; 1: Over-high

ID	Bit	Item	Value
1033	Bit 8	Battery 2 temperature over-high	0: Normal; 1: Over-high
	Bit 9	Battery 1 grounding failure	0: Normal; 1: Failure
	Bit 10	Battery 2 grounding failure	0: Normal; 1: Failure
	Bit 11	Master channel frequency abnormal	0: Normal; 1: Excessive
	Bit 12	Balance inductor over-temperature	0: Normal; 1: Over-temperature
	Bit 13	Input inductor over-temperature	0: Normal; 1: Over-temperature
	Bit 14	Rectifier over-temperature	0: Normal; 1: Over-temperature
	Bit 15	Balance circuit failure	0: Normal; 1: Failure
1034	Bit 0	Balance inductor over-current	0: Normal; 1: Over-current
	Bit 1	Master fuse broken	0: Normal; 1: Broken
	Bit 2	Auxiliary power 1 power-off	0: Normal; 1: Failure
	Bit 3	Master channel phase sequence reverse	0: Normal; 1: Failure
	Bit 4	Rectifier over-current	0: Normal; 1: Failure
	Bit 5	Software start failure	0: Normal; 1: Failure
	Bit 6	Inversion inductor over-temperature	0: Normal; 1: Over-temperature
	Bit 7	Inductor ove-temperature	0: Normal; 1: Over-temperature
	Bit 8	Inversion thyristor failure	0: Normal; 1: Failure
	Bit 9	User operation error	0: Normal; 1: Error
	Bit 10	Output fuse broken	0: Normal; 1: Broken
	Bit 11	Single unit output overload	0: Normal; 1: Overload
	Bit 12	Combined system overload	0: Normal; 1: Overload
	Bit 13	Single unit overload timeout	0: Normal; 1: Overload timeout
	Bit 14	AC output over-voltage	0: Normal; 1: Over-voltage
Bit 15	Inverter over-current	0: Normal; 1: Over-current	
1035	Bit 0	Turning to bypass due to load impact	0: Normal; 1: Failure
	Bit 1	Failure of current sharing in combined units	0: Normal; 1: Failure
	Bit 2	Abnormal power-off of bus	0: Normal; 1: Failure
	Bit 3	Turning to bypass due to request by neighbor system	0: Normal; 1: Failure
	Bit 4	DC bus over-voltage failure	0: Normal; 1: Failure
	Bit 5	Rectifier communication failure	0: Normal; 1: Failure
	Bit 6	Inverter communication failure	0: Normal; 1: Failure
	Bit 7	Output DC excess failure	0: Normal; 1: Failure
	Bit 8	Combined system battery pre-alarm failure	0: Normal; 1: Failure
	Bit 9	Input zero-lacking failure	0: Normal; 1: Failure
	Bit 10	Inversion contactor failure	0: Normal; 1: Failure
	Bit 11	Input contactor failure	0: Normal; 1: Failure
	Bit 12	Input current abnormal	0: Normal; 1: Failure
	Bit 13	Output voltage abnormal	0: Normal; 1: Failure
	Bit 14	Input current excessive	0: Normal; 1: Failure
Bit 15	Bypass over-temperature	0: Normal; 1: Failure	
1036	Bit 0	Thyristor failure in neighboring unit	0: Normal; 1: Failure
	Bit 1	External input isolated transformer over-temperature	0: Normal; 1: Failure
	Bit 2	External input isolated transformer fan failure	0: Normal; 1: Failure
	Bit 3	Bypass transformer over-temperature	0: Normal; 1: Failure
	Bits 4~15	Reserved	

3. UPS status data

ID	Bit	Item	Value
1040	Bits 1/0	Power supply mode	00: UPS power supply 01: Bypass power supply 10: No power supply
	Bit 2	Battery 1 self-check	0: In self-check; 1: Not in self-check
	Bits 4/3	Battery 1 average charge/floating charge	00: Floating charge 01: Average charge 10: Non-charging status

ID	Bit	Item	Value
1040	Bit 5	Integrated equipment power-on/off	0: Power-off; 1: Power-on
	Bit 7/6	Rectifier power supply status	00: Master channel input, rectifier started 01: Battery input, rectifier started 10: Combined input, rectifier started 11: No input from master channel or batteries
	Bit 8	Integrated generator access event	0: Generator accessed 1: Generator not accessed
	Bit 9	Integrated equipment input air breaker status	0: Disconnected; 1: Closed
	Bit 10	Integrated equipment maintenance bypass air breaker status	0: Disconnected; 1: Closed
	Bit 11	Integrated equipment bypass air breaker status	0: Disconnected; 1: Closed
	Bit 12	Integrated equipment output air breaker status	0: Disconnected; 1: Closed
1041	Bits 15/14/13	Integrated equipment revolving air breaker status	000: Closed 001: Under test 010: Normal 011: Bypass 100: Maintenance
	Bits 2/1/0	Rack combined system power supply status	000: No power supply 001: Bypass power supply 010: Mains supply 011: Battery inversion power supply 100: United power supply 101: Output prohibited
	Bit 3	Battery 2 battery self-check	0: In self-check; 1: Not in self-check
	Bit 5/4	Battery 2 floating / average charge status	00: Floating charge 01: Average charge 10: Non charge
	Bit 6	Module 1 online or offline	0: Online; 1: Offline
	Bit 7	Module 2 online or offline	0: Online; 1: Offline
	Bit 8	Module 3 online or offline	0: Online; 1: Offline
	Bit 9	Module 4 online or offline	0: Online; 1: Offline
	Bit 10	Module 5 online or offline	0: Online; 1: Offline
	Bit 11	Module 6 online or offline	0: Online; 1: Offline
	Bit 12	Module 7 online or offline	0: Online; 1: Offline
	Bit 13	Module 8 online or offline	0: Online; 1: Offline
	Bit 14	Module 9 online or offline	0: Online; 1: Offline
	Bit 15	Module 10 online or offline	0: Online; 1: Offline

4. UPS analog data

ID	Byte	Item	Value
1050	2	Input phase voltage A	0.1V
1051	2	Input phase voltage B	0.1V
1052	2	Input phase voltage C	0.1V
1053	2	Output phase voltage A	0.1V
1054	2	Output phase voltage B	0.1V
1055	2	Output phase voltage C	0.1V
1056	2	Output phase current A	0.1A
1057	2	Output phase current B	0.1A
1058	2	Output phase current C	0.1A
1059	2	DC input voltage (Battery 1 voltage)	0.1V
1060	2	Output frequency (consistency in three phases)	0.01Hz
1065	2	Input cable voltage AB	0.1V
1066	2	Input cable voltage BC	0.1V
1067	2	Input cable voltage CA	0.1V
1068	2	Input phase current A	0.1A
1069	2	Input phase current B	0.1A
1070	2	Input phase current C	0.1A
1071	2	Input frequency (consistency in three phases)	0.01Hz
1072	2	Phase A input power factor	0.01

ID	Byte	Item	Value
1073	2	Phase B input power factor	0.01
1074	2	Phase C input power factor	0.01
1075	2	Bypass phase voltage A	0.1V
1076	2	Bypass phase voltage B	0.1V
1077	2	Bypass phase voltage C	0.1V
1078	2	Bypass frequency	0.01Hz
1079	2	Phase A output power factor	0.01
1080	2	Phase B output power factor	0.01
1081	2	Phase C output power factor	0.01
1082	2	Phase A output peak ratio	0.01
1083	2	Phase B output peak ratio	0.01
1084	2	Phase C output peak ratio	0.01
1085	2	Phase A output active power	0.01kW
1086	2	Phase B output active power	0.01kW
1087	2	Phase C output active power	0.01kW
1088	2	Phase A output reactive power	0.01kVA
1089	2	Phase B output reactive power	0.01kVA
1090	2	Phase C output reactive power	0.01kVA
1091	2	Phase A output apparent power	0.01kVA
1092	2	Phase B output apparent power	0.01kVA
1093	2	Phase C output apparent power	0.01kVA
1094	2	Phase A output load percentage	0.01
1095	2	Phase B output load percentage	0.01
1096	2	Phase C output load percentage	0.01
1097	2	Battery backup time	Minute
1098	2	Positive battery voltage	0.1V
1099	2	Positive battery current	0.1A
1100	2	Negative battery voltage	0.1V
1101	2	Negative battery current	0.1A
1102	2	Battery aging coefficient	0.1
1103	2	Battery temperature	0.1℃
1104	2	Environmental temperature	0.1℃

5. SPM alarm data

ID	Bit	Item	Value
2000	Bit 2/1/0	Reserved	
	Bit 3	Inside communication status	0: Normal; 1: Alarm
	Bit 4	Input dry contactor 1 status	0: Normal; 1: Alarm
	Bit 5	Input dry contactor 2 status	0: Normal; 1: Alarm
	Bit 6	Input dry contactor 3 status	0: Normal; 1: Alarm
	Bit 7	Input dry contactor 4 status	0: Normal; 1: Alarm
	Bit 8	Collaction board 5 ready status	0: Normal; 1: Alarm
	Bit 9	Collaction board 6 ready status	0: Normal; 1: Alarm
	Bit 10	Collaction board 7 ready status	0: Normal; 1: Alarm
	Bit 11	Collaction board 8 ready status	0: Normal; 1: Alarm
	Bit 12	Collaction board 10 ready status	0: Normal; 1: Alarm
	Bit 13	Collaction board 11 ready status	0: Normal; 1: Alarm
	Bit 14	Collaction board 12 ready status	0: Normal; 1: Alarm
	Bit 15	CRC check status	0: Normal; 1: Alarm
	2001+n (0≤N≤17)	Bit 0	Branch 3n+1 over-current
Bit 1		Branch 3n+1 ultra-high current threshold	0: Normal; 1: Alarm
Bit 2		Branch 3n+1 low current threshold	0: Normal; 1: Alarm
Bit 3		Branch 3n+1 impact over-current	0: Normal; 1: Alarm
Bit 4		Branch 3n+1 switch abnormal	0: Normal; 1: Alarm
Bit 5		Branch 3n+2 over-current	0: Normal; 1: Alarm
Bit 6		Branch 3n+2 ultra-high current threshold	0: Normal; 1: Alarm
Bit 7		Branch 3n+2 low current threshold	0: Normal; 1: Alarm
Bit 8	Branch 3n+2 impact over-current	0: Normal; 1: Alarm	

ID	Bit	Item	Value
2001+n (0≤N≤17)	Bit 9	Branch 3n+2 switch abnormal	0: Normal; 1: Alarm
	Bit 10	Branch 3n+3 over-current	0: Normal; 1: Alarm
	Bit 11	Branch 3n+3 ultra-high current threshold	0: Normal; 1: Alarm
	Bit 12	Branch 3n+3 low current threshold	0: Normal; 1: Alarm
	Bit 13	Branch 3n+3 impact over-current	0: Normal; 1: Alarm
	Bit 14	Branch 3n+3 switch abnormal	0: Normal; 1: Alarm

6. SPM analog data

ID	Byte	Item	Value
1128	2	SPM Branch 1 current	0.1A
1129	2	SPM Branch 1 power(kWh)	0.1kWh
1130	2	SPM Branch 1 switch status	1
1131	2	SPM Branch 1 active power	0.1kW
1132	2	SPM Branch 1 apparent power	0.1kW
1133	2	SPM Branch 1 THDi	0.01
1134	2	SPM Branch 1 rated current	0.1A
1135	2	SPM Branch 1 load ratio	0.01
1136	2	SPM Branch 1 power factor	0.01
1137	2	SPM Branch 1 reserved	
1138	2	SPM Branch 1 reserved	
1139	2	SPM Branch 1 reserved	
1140	2	SPM Branch 1 reserved	
1141	2	SPM Branch 1 reserved	
1142	2	SPM Branch 1 reserved	
1143	2	SPM Branch 2 current	0.1A
1144	2	SPM Branch 2 power(kWh)	0.1kWh
1145	2	SPM Branch 2 switch status	1
1146	2	SPM Branch 2 active power	0.1kW
1147	2	SPM Branch 2 apparent power	0.1kW
1148	2	SPM Branch 2 THDi	0.01
1149	2	SPM Branch 2 rated current	0.1A
1150	2	SPM Branch 2 load ratio	0.01
1151	2	SPM Branch 2 power factor	0.01
1152	2	SPM Branch 2 reserved	
1153	2	SPM Branch 2 reserved	
1154	2	SPM Branch 2 reserved	
1155		SPM Branch 2 reserved	
1156		SPM Branch 2 reserved	
1157		SPM Branch 2 reserved	
.....		
1923		SPM Branch 54 current	0.1A
1924		SPM Branch 54 power(kWh)	0.1kWh
1925		SPM Branch 54 switch status	1
1926		SPM Branch 54 active power	0.1kW
1927		SPM Branch 54 apparent power	0.1kW
1928		SPM Branch 54 THDi	0.01
1929		SPM Branch 54 rated current	0.1A
1930		SPM Branch 54 load ratio	0.01
1931		SPM Branch 54 power factor	0.01
1932		SPM Branch 54 reserved	
1933		SPM Branch 54 reserved	
1934		SPM Branch 54 reserved	
1935		SPM Branch 54 reserved	
1936		SPM Branch 54 reserved	
1937		SPM Branch 54 reserved	
.....		
1999		Reserved	

Chapter 4 Troubleshooting

1. After plugging the adapter in the SNMP slot of the UPS or FLP, the yellow LED (equipment communication LED) of the adapter does not illuminate.

Cause analysis and solution: the UPS or FLP is off or has no mains input. Please turn on the UPS or FLP; if the UPS or FLP cannot be turned on, please connect the mains input to the UPS or FLP and try again.

2. After the adapter is installed, the yellow LED (equipment communication LED) of the adapter illuminates, and the host monitoring software cannot monitor the UPS or FLP normally.

Cause analysis and solution: the UPS or FLP is on, but the communication between the adapter and the UPS or FLP has not been established. Please pull out the adapter, check for the presence and proper insertion of the chip on the PCB. If the check proves satisfactory, the adapter must be damaged, please contact the customer service center of Emerson.

3. After the adapter is installed, the yellow LED (equipment communication LED) of the adapter flashes about once per 5s, and the host monitoring software cannot monitor the UPS or FLP normally.

Cause analysis and solution: the yellow LED flashing once per 5s indicates the adapter cannot detect the UPS or FLP or recognize the UPS or FLP type. Please check if the adapter matches the UPS or FLP type according to the hardware description in section 1.3. The adapter can recognize the UPS or FLP type. After it recognizes the UPS or FLP, the yellow LED will flash quickly, about once per 1s.

4. The yellow LED (equipment communication LED) flashes quickly, the green LED (host communication LED) is off.

Cause analysis and solution: the adapter is not properly connected to the host computer. Please properly connect the adapter to the host computer following the instructions provided in section 2.3.3.

5. The yellow LED (equipment communication LED) flashes quickly, the green LED (host communication LED) flashes too, but the host monitoring software cannot monitor the UPS or FLP normally.

Cause analysis and solution: the yellow LED flashing quickly indicates the communication between the adapter and the UPS or FLP is normal; if the green LED flashes but the host monitoring software cannot detect the UPS or FLP data, please check that: 1) the communication cable is properly connected between the adapter and the host computer; 2) the adapter's physical address and communication baud rate settings are the same as those set in the host monitoring software; 3) the adapter's physical address setting does not conflict with that of any other monitored equipment (applicable only in RS485 cascade connection).