



ACR系列网络多功能电力仪表 ACR Series Network Multi-functional Power Meters

安装使用说明书 Installation and Operation Instruction

上海安科瑞电气有限公司
Shanghai Acrel Co., Ltd.

总部: 上海安科瑞电气有限公司
Headquarter: Shanghai Acrel Co., Ltd.
地址: 上海市嘉定区棕坊桥洪德路99号
Add: No. 99 Hongde Road, Zong Fang Qiao,
Jiading District, Shanghai
Tel: (86) 21-59104850 59104851
Fax: (86) 21-59104852
服务热线Service Hot Line: 800-820-6632
Http: //www.acrel.cn E-mail: ACREL001@vip.163.com
PC: 201801

生产基地: 江苏安科瑞电器制造有限公司
Production Base: Jiangsu Acrel Appliance Manufacture Co., Ltd.
地址: 江阴市南闸镇东盟工业园区东盟路5号
Add: 5 Domeng Road Dongmeng Industrial Park Nanzha town Jiangyin
Tel: (86) 0510-86179966 86179967 86179968
Fax: (86) 0510-86179975
PC: 214405
E-mail: JY-ACREL001@vip.163.com

申 明 DECLARATION

版权所有，未经本公司之书面许可，此手册中任何段落，章节内容均不得被摘抄、拷贝或以任何形式复制、传播，否则一切后果由违者自负。
本公司保留一切法律权利。

No part of this publication may be reproduced, stored in a retrieval system, or transmitted in any form by any means, electronic, mechanical photocopying, recording, or otherwise without prior permission of Acrel. All rights reserved.

本公司保留对本手册所描述之产品规格进行修改的权利，恕不另行通知。
订货前，请垂询当地代理商以获悉本产品的最新规格。

This company reserve power of revision of product specification described in this manual, without notice. Before ordering, please consult local agent for the latest specification of product.

目 录 CONTENTS

1 概述 General	1
2 产品规格 Product specification	2
3 技术参数 Technical parameters	3
4 安装与接线 Installing and wiring	4
4.1 外形及安装尺寸 Outline overall and installing dimensions	4
4.2 安装方法 Installing method	5
4.3 接线方法 Wiring method	5
4.4 注意事项 Notice	7
5 编程与使用 Program and Usage	8
5.1 测量项目及面板说明 Explanation for metering items and faceplate	8
5.2 按键功能说明 Explanation for keypad functionality	10
5.3 操作说明 Explanation for operation	11
5.4 编程菜单 Program menu	15
5.4.1 仪表通用编程菜单 Meters general Program menu	15
5.4.2 LCD显示仪表增加的背光控制菜单 Adding backlight control menu to LCD display meters	16
5.4.3 带开关量仪表增加菜单 Added menu with switching meters	16
5.4.4 带复费率仪表增加菜单 Added menu with multi-rate meters	17
5.5 编程示例 Example programming	18
5.5.1 如何修改电流变比 How to revise transformation ratio of current	18
5.5.2 如何修改变送设置 How to revise transform settings	19
5.5.3 编程设置流程图 Programming set flow chart	21
6 通讯 Coomunication	22
6.1 通讯协议概述 Summarizing communication protocol	22
6.1.1 传输方式 Transmission mode	22
6.1.2 信息帧格式 Information frame format	23
6.2 功能码简介 Briefing forfunctional code	25
6.2.1 功能码03H或04H: 读寄存器 Functional code 03Hor04H: register reading	25
6.2.2 功能码10H: 写寄存器 Functional code 10H: register writing	26
6.2.3 功能码x8H: 读电能数据 Functional code x8H: electric energy reading	27
6.3 通讯应用细节 Details of communication application	28
6.3.1 开关量输入与输出 Switching input and output	28
6.3.2 电力参数与电能 Power parameter and electric energy	30

1 概述 General

ACR系列网络多功能电力仪表,是针对电力系统,工矿企业,公用设施,智能大厦的电力监控需求而设计的一种智能表,它集成全部电力参数的测量(如单相或者三相的电流、电压、有功功率、无功功率、视在功率、频率、功率因数)以及全面的电能计量和考核管理(如四象限电能计量和分时电能统计、最大需量记录及12月电能统计等)。同时它具有多种外围接口功能可供用户选择:带有RS485通讯接口,采用MODBUS-RTU协议可满足通讯联网管理的需要; 4-20mA的模拟量输出可与任意测量的电参量相对应,满足DCS等接口要求;带开关量输入和继电器输出可实现断路器开关的遥信和遥控的功能,采用高亮度LED/LCD显示界面,通过面板按键来实现参数设置和控制,非常适合于实时电力监控系统。

ACR系列网络电力仪表具有极高的性能价格比,可以直接取代常规电力变送器及测量仪表。作为一种先进的智能化、数字化的前端采集元件,该电力仪表已广泛应用于各种控制系统,SCADA系统和能源管理系统中。

ACR Series Network Multi-Functional Power Meters, is a intelligent meter, designed for power monitoring of Power Systems, industrial and mining establishments, public utility, intelligent building. It integrate all the power parameters measurement(such as single phase or three phase's current, voltage, active power, reactive power, apparent power, frequency, power factor) and all-sided electric energy measurement and checking management (such as four quadrant electric energy measurement and time sharing electric energy statistics, maximum demand record and December electric energy statistics etc.) .At same time, it has many peripheral interfaces function for users selecting:fitted with RS485 Communication interface, adopting MODBUS-RTU protocol, the demand of communication networking management may be satisfied; 4-20mA analog output may be corresponding to any measurement of electric parameters to satisfy demand of DCS interface etc.; fitted with switching input and relay output can realize "signaling" and "elecontrol" function of circuit breaker, adopting high brightness LED/LCD display interface, pressing faceplate keypad realize setting and controlling of parameters, very suitable for real time power monitoring system.

ACR Series Network Multi-Functional Power Meters have very high price performance ratio, can directly replace the general power transmitter and measurement meters. As an advanced intelligent, digital Front-end acquisition component, these meters are widely used in various control systems, SCADA system and energy source management system.

2 产品规格 Product specification

仪表型号 Type of meters	基本功能 Basic function	外形 Outline	可选功能 Optional function
ACR100E	四象限电能计量; LED显示、RS485通讯 Four quadrant electric energy measurement; LED Display、RS485Communication	80 方形	1、一路变送输出+有功脉冲+无功脉冲; 2、两路开关量输入+两路开关量输出; 1、1 channel transmitting output + active pulse + reactive pulse; 2、2 channels switching input +2 channels switching output
ACR110E	三相电流测量、有功电能计量; LED显示、RS485通讯 Three-phase current measurement, active electric energy measurement; LED Display、RS485Communication		
ACR120E	三相所有电力参数测量、四象限电能计量;LED显示、RS485通讯 Three-phase all power parameters measurement, four quadrant electric energy measurement; LED Display、RS485Communication		
ACR120EL	三相所有电力参数测量、四象限电能计量;LCD显示、RS485通讯 Three-phase all power parameters measurement, four quadrant electric energy measurement; LCD Display、RS485Communication		
ACR120EFL	三相所有电力参数测量、四象限电能计量和分时电能统计、最大需量记录及12月电能统计日期时间显示、LCD显示、RS485通讯 Three-phase all power parameters measurement, four quadrant electric energy measurement and time sharing electric energy statistics, maximum demand record and December electric energy statistics date and time Display、LCD Display、RS485Communication	96 方形	1、两路变送输出+有功脉冲+无功脉冲; 2、四路开关量输入+有功脉冲; 3、两路开关量输入+两路开关量输出(LCD显示可带四路开关量输入+两路开关量输出); 1、2 channel transmitting output +active pulse+reactive pulse; 2、4 channels switching input + active pulse; 3、2 channels switching input +2 channels switching output (LCD Display fitted with 4 channels switching input+2 channels switching output),
ACR200E	四象限电能计量; LED显示、RS485通讯 Four quadrant electric energy measurement; LED Display、RS485Communication		
ACR210E	三相电流测量、有功电能计量; LED显示、RS485通讯 Three-phase current measurement active electric energy measurement; LED Display、RS485Communication		
ACR220E	三相所有电力参数测量、四象限电能计量;LED显示、RS485通讯 Three-phase all power parameters measurement, four quadrant electric energy measurement; LED Display、RS485Communication		
ACR220EL	三相所有电力参数测量、四象限电能计量;LCD显示、RS485通讯 Three-phase all power parameters measurement, four quadrant electric energy measurement; LCD Display、RS485Communication	96 方形	1、四路变送输出+有功脉冲+无功脉冲; 2、四路开关量输入四路开关量输出; 1、4 channels transmitting output +active pulse+reactive pulse; 2、4 channels switching input 4 channels switching output;
ACR220EFL	三相所有电力参数测量、四象限电能计量和分时电能统计、最大需量记录及12月电能统计日期时间显示、LCD显示、RS485通讯 Three-phase all power parameters measurement, four quadrant electric energy measurement and time sharing electric energy statistics, maximum demand record and December electric energy statistics date and time Display、LCD Display、RS485Communication		
ACR300E	四象限电能计量; LED显示、RS485通讯 Four quadrant electric energy measurement; LED Display、RS485Communication		
ACR310E	三相电流测量、有功电能计量; LED显示、RS485通讯 Three-phase current measurement, active electric energy measurement; LED Display、RS485Communication		
ACR320E	三相所有电力参数测量、四象限电能计量;LED显示、RS485通讯 Three-phase all power parameters measurement, four quadrant electric energy measurement; LED Display、RS485Communication	42 方形	1、4 channels transmitting output +active pulse+reactive pulse; 2、4 channels switching input 4 channels switching output;
ACR320EL	三相所有电力参数测量、四象限电能计量;LCD显示、RS485通讯 Three-phase all power parameters measurement, four quadrant electric energy measurement; LCD Display、RS485Communication		
ACR320EFL	三相所有电力参数测量、四象限电能计量和分时电能统计、最大需量记录及12月电能统计日期时间显示、LCD显示、RS485通讯 Three-phase all power parameters measurement, four quadrant electric energy measurement and time sharing electric energy statistics, maximum demand record and December electric energy statistics date and time Display、LCD Display、RS485Communication		
ACR400E	四象限电能计量; LED显示、RS485通讯 Four quadrant electric energy measurement; LED Display、RS485Communication		
ACR410E	三相电流测量、有功电能计量; LED显示、RS485通讯 Three-phase current measurement, active electric energy measurement; LED Display、RS485Communication	144 方形	1、4 channels transmitting output; 2、8 channels switching input 2 channels switching output + active pulse
ACR420E	三相所有电力参数测量、四象限电能计量;LED显示、RS485通讯 Three-phase all power parameters measurement, four quadrant electric energy measurement; LED Display、RS485Communication		

3 技术参数 Technical parameters

技术参数 Technical parameters	指标 Value	
网络 Network	三相三线、三相四线 Three-phase three wire, three-phase four wire	
频率 Frequency	45~65Hz	
输入 Input	电压 Voltage	额定值: AC100V、400V Rating: AC100V、400V 过负荷: 1.2倍额定值(连续); 2倍额定值持续1秒 Overload: 1.2 times Rating (continuous); 2 times Rating for 1 second
	电流 Current	功耗: 小于0.2VA Power consumption: less than 0.2VA
		额定值: AC1A、5A Rating: AC1A、5A 过负荷: 1.2倍额定值(连续); 10倍额定值持续1秒 Overload: 1.2 times Rating (continuous); 10 times Rating for 1 second
输出 Output	电能 Electric energy	输出方式: 集电极开路的光耦脉冲, 2路输出 Output mode: open-collector photo-coupler pulse, 2 channels Output 脉冲常数: 10000、40000、160000 imp/kWh Pulse constant: 10000、40000、160000 imp/kWh
	通讯 Communication	RS485接口、Modbus-RTU协议 RS485 interface, Modbus-RTU protocol
	显示 Display	LED、LCD
开关量输入 Switching input	2、4或8路干接点输入, 内置+5V电源 2, 4 or 8 channels dry contacts Input, embedded +5V Power supply	
开关量输出 Switching output	输出方式: 2或4路继电器常开触点输出 Output mode: 2 or 4 channels relay NO contact Output	
	触点容量: AC 250V/3A、DC 30V/3A Contact capacity: AC 250V/3A, DC 30V/3A	
变送输出 Transmitting output	输出方式: 1、2或4路输出, 0~20mA、4~20mA可编程 Output mode: 1, 2 or 4 channels Output, 0~20mA, 4~20mA programmable	
	负载能力: ≤500Ω Load capacity: ≤500Ω	
测量精度 Measurement Precision	频率0.05Hz、无功电能1级、其它0.5级 Frequency 0.05Hz, reactive Electric energy 1 class, other 0.5 class	
电源 Power supply	AC/DC 85~270V; 功耗≤4VA AC/DC 85~270V; Power consumption≤4VA	
安全性 Safety	工频耐压: 电源、电压输入回路、电流输入回路两两之间AC2kV/1min; 电源与开关量输入回路、通讯回路、变送输出回路之间AC1.5kV/1min 绝缘电阻: 输入、输出端对机壳>5MΩ Power frequency withstand voltage: Between Power supply, voltage Input circuit, current Input circuit AC2kV/1min; Between Power supply and switching input circuit, Communication circuit, transmitting Output circuit AC1.5kV/1min; Insulation resistance: Input, Output end to machine enclosure >5MΩ	
环境 Environment	工作温度: -10℃~+45℃; 储存温度: -20℃~+70℃ 相对湿度: 5%~95% 不结露; 海拔高度: ≤2500m Operational temperature: -10℃~+45℃; storage temperature: -20℃~+70℃ Relative humidity: 5%~95% no condensation; Altitude: ≤2500m	

4 安装与接线 Installing and Wiring

4.1 外形及安装开孔尺寸(单位: mm)

4.1 Outline and mounting cutout size (Unit: mm)

ACR1xx系列

ACR1xxSeries

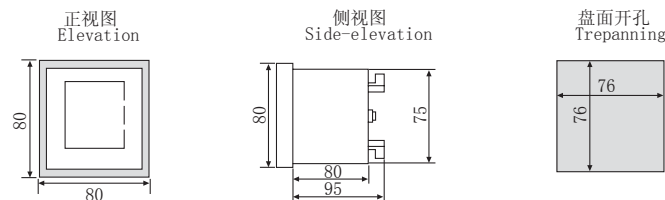

ACR2xx系列

ACR2xxSeries

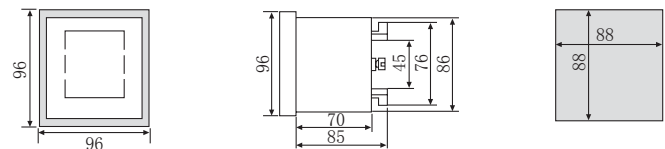

ACR3xx系列

ACR3xxSeries

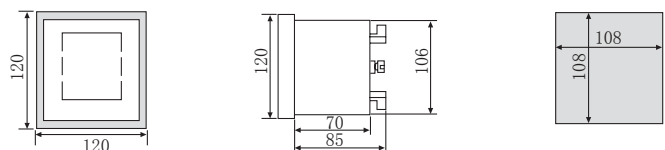

ACR4xx系列

ACR4xxSeries

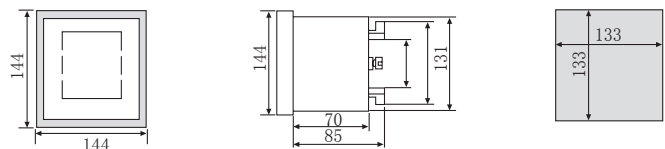

4.2 安装方法

ACR系列网络电力仪表安装方式为嵌入式，固定方式为挤压式，具体操作如下：

- 1、在配电盘上，选择适合的地方开一个与所安装多功能仪表开孔尺寸相同的安装孔；
- 2、取出网络电力仪表，松开定位螺钉（逆时针），取下安装支架；
- 3、把仪表插入配电盘仪表孔中，插入仪表后装上安装支架、定位螺钉（顺时针）。

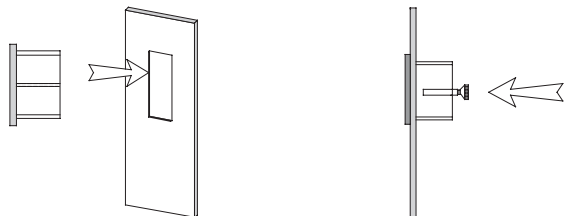

4.2 Installation method

ACR Series Network power meters adopt the embedded mode as mounting mode, take pressing mode as fixing mode, concrete operations are shown as following:

- 1, On proper place of the distribution switchboard, make one mounting hole with same size of multi-function meters cutout;
- 2, Remove Network power meters, loosening the positioning screw (counter clockwise), remove mounting support;
- 3, Insert meters into meter-hole of distribution switchboard, after the meter is inserted, restore mounting support and positioning screw (clockwise).

4.3 接线方法（注：如与仪表壳体上接线图不一致，以仪表壳体上接线图为准）

4.3.1 电压电流信号端子

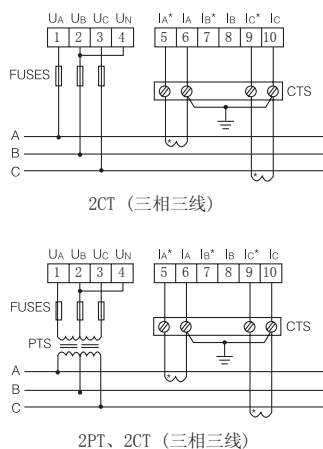

4.3 Wiring method (Note: If it is different from the Wiring diagram on the meters cabinet, follows the Wiring diagram on the meters cabinet)

4.3.1 Voltage current signal terminal

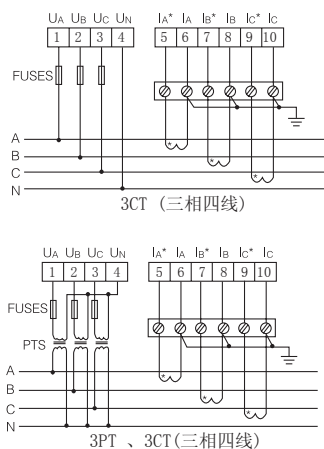

4.3.2 开关量输入输出

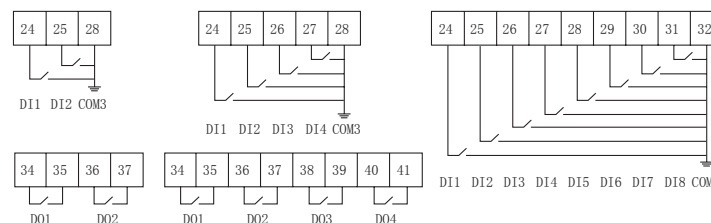

4.3.2 Switching input Output

4.3.3 电源、RS485、脉冲输出

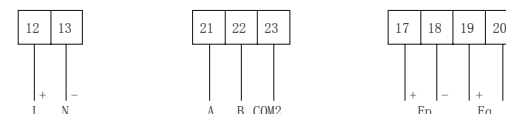

4.3.3 Power supply, RS485, pulse Output

4.3.4 模拟量变送输出

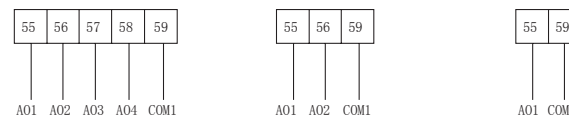

4.3.4 Analog transmitting output

4.4 注意事项

4.4.1 电压输入

输入电压应不高于产品的额定输入电压（100V或400V）的120%，否则应考虑使用PT；

在电压输入端须安装1A保险丝；

4.4.2 电流输入

标准额定输入电流为5A或1A，大于5A的情况应使用外部CT；

接线时确保输入电流与电压相序一致，即1号接线端接A相电压则5、6号接线端一定要接A相电流，否则会出现显示数值和符号错误；同时确保电流进出线连接正确（打*号端子接进线）；

如果使用的CT上连有其它仪表，接线应采用串接方式；

安装接线时建议使用接线排，不要直接接CT，以便于拆装；

去除产品电流输入连线前，必须先切断CT一次回路或者短接二次回路！

4.4.3 通讯接线

该仪表提供异步半双工RS485通讯接口，采用MODBUS-RTU协议，各种数据信息均可在通讯线路上传送。理论上在一条线路上可以同时连接多达128个仪表，每个仪表均可设定其通讯地址（Addr），通讯速率（baud）也可通过设置选择。

通讯连接建议使用三芯屏蔽线，线径不小于0.5mm²，分别接A、B、COM，屏蔽层接大地，布线时应使通讯线远离强电电缆或其他强电场环境。

建议最末端仪表的A、B之间加匹配电阻，阻值范围为120Ω~10kΩ。

4.4 Notice

4.4.1 Voltage Input

Input voltage should not higher than 120% of product's Input voltage(100V or400V), otherwise, should use PT;

1A fuse should be mounted on the voltage Input end;

4.4.2 Current Input

Standard rated Input current is 5A or1A, if greater than 5A, the external CT should be used;

When wiring, ensure that the Input current and voltage has same phase sequence, i.e. if 1# terminal is connected with A phase voltage, then 5, 6# terminal must be connected with A phase current, otherwise, Display value and symbol error may occur; while ensure the connection correctness of current inlet and outlet(symbol * terminal connecting with inlet);

If the used CT connected with other meters, the connection is adopting series connection mode;

When wiring, using Connector bar is recommended, not connected with CT directly, to facilitate dismantling;

Before removing product current Input connection, firstly, cutoff CT primary circuit or short the secondary circuit!

4.4.3 Communication connection

This meter provides asynchronism haif duplex RS485 Communication interface, adopts MODBUS-RTU protocol, various data information may be transmitting on the Communication line.Theoretically, on the same line, meters up to 128 may be connected at the same time, each meter can set up its Communication address(Addr), Communication rate(baud) may be selected.

Communication connection recommendation of three-core shielded wire, its linear diameter is no less than0.5mm², separately connecting A, B, COM, the shielded layer connecting earth, when wiring, the Communication line shall be far away from strong current cable or other strong electric field environment.

Recommendation of adding matched resistance between A, B of the last meter, the rated rcistance range is 120Ω~10kΩ.

5 编程与使用 Program and usage

5.1 测量项目及面板说明

ACR网络电力仪表面板右侧V123指示灯点亮时三排数码管分别显示三相电压；I123指示灯点亮时三排数码管分别显示三相电流；PQλ指示灯点亮时三排数码管分别显示总有功功率、总无功功率、总功率因数；面板上左边三个灯为功率负号指示灯，当任一负号灯点亮时表明该排显示值为负值；EPQ指示灯点亮表示显示项目为电能，ACR网络电力仪表可以计量四象限电能数据：

EPI--吸收有功电能

EPE--释放有功电能

EQL--感性无功电能

EQC--容性无功电能。

右侧k、M代表所显示项目的单位数量级为千或兆。

例：如下图所示，“EPQ”指示灯亮，第一排数码管显示EPI，表示当前显示吸收有功电能，k指示灯亮，表示电能单位为kWh，读电能时将第二排数码管和第三排数码管连读，如下图所示电能为123456.78kWh。

5.1 Explanation for measurement items and faceplate

On the ACR Network power meters faceplate, when its right side V123 indicator lights, three rows digitron separately Displays three-phase voltage; I123indicator lights, three rows digitron separately Displays three-phase current; PQ indicator lights, three rows digitron separately Displays total active power, total reactive power, total power factor; but its top-left three indicators as power minus sign indicators, when any minus sign indicator lights, this shows the Displaying is negative value; EPQ indicator lights, shows the Displaying item is Electric energy, ACR Network power meters can measure four quadrant Electric energy data:

EPI-- capture active Electric energy

EPE-- release active Electric energy

EQL-- Inductive reactive Electric energy

EQC-- capacitive reactive Electric energy.

Right side k, M: k=kilo; M= million

Example: As below figure shows: EPQ indicator lights, the first row digitron Display EPI, currently Display the capture active Electric energy, k indicator lights, shows Electric energy Unit is kWh, the Electric energy reading value is the second row digitron plus the third row digitron, the Electric energy shown in below figure is 123456.78kWh.

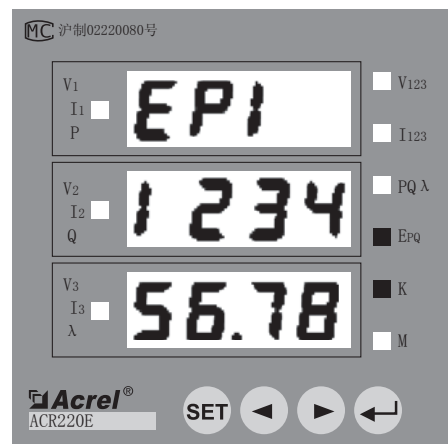

注:

1、通常情况下，用户都是用电状态，此时应读取EPI值（吸收有功电能）；发电厂向外发电时读取EPE值（释放有功电能）。如果用户既有用电情况、又有发电机向外发电情况，则仪表EPI和EPE里都会有电能显示。

2、ACR仪表显示电能值时，LED(数码管)型指示的电能数据为一次侧电能，此值无须再乘以电流、电压变比。LCD（液晶）型指示的电能数据为二次侧电能值，该值乘以电流、电压变比才是一次侧电能值。

3、当用户发现电能或功率指示明显不正常时，可通过查看三个分相功率的数值和符号确认有无接线错误。切换到PQλ指示灯亮，三排数码显示总有功功率、总无功功率、三相功率因数时长按住回车键，此时三排数码分别显示PA、PB、PC三个分相有功功率，若用电状态时存在任一相功率为负（负号指示灯亮）均属不正常。检查该相电流电压接线，观察是否存在CT进出线反，或电压与电流相序不对应等情况。若用户采用3相3线接线方式（2CT接法），长按住回车键时显示两个分相功率，不能使用上述方法判断，建议客户咨询我司技术支持人员。

Note:

1、In a general way, users is in electricity utilization, at this time, read EPI value (capture active Electric energy); if power plant output of its power, read EPE value (release active Electric energy) .If users use power and generate power for other, then Electric energy Display appear in meters of EPI and EPE.

2、When ACR meters Display Electric energy value, LED (digitron) indicated Electric energy data is the primary side Electric energy, this value need not be multiplied by current, voltage transformation ratio. But LCD (liquid crystal) indicated Electric energy data is the secondary side Electric energy value, This value need be multiplied by current, voltage transformation ratio to display primary side Electric energy value.

3、When user discover that the display of Electric energy or power is abnormal clearly, may check three phase splitting power value and symbols for error wiring. Switch to PQλ indicator lights, three-row digitron Display total active power, total reactive power, three-phase power factor, pressing ENTER button, for long time, at this time, three-row digitron separately Display PA、PB、PC three spliting phase active power, if use power but any phase splitting power is negative(minus sign indicator lights),it is abnormal. Check This phase current, voltage connection, to see if CT inlet and outlet is reversal, or voltage and current with improper phase sequence. If the user adopts the three-phase-three-wire connection mode (2CT connection), pressing ENTER button for long time, to Display two phase splitting power, the above judge method is not proper, please consult our technical support personnel.

5.2 按键功能说明

ACR网络电力仪表四个按键从左至右依次为SET键、左键、右键、回车键。

5.2 Explanation for keypad function

ACR Network power meters have four keystrokes, from left to right they are :SET key, left button, right button, ENTER button .

SET键 SET key	测量模式下，按该键进入编程模式，仪表提示输入密码CODE输入正确密码后，可对仪表进行编程设置；编程模式下，用于返回上一级菜单 Under measurement mode, Press This key enter programming mode, meters hint Input password CODE, after Input correct password, set up meters programming; Under programming mode, used for Return to previous menu
左键 Left button	测量模式下，用于切换显示项目；编程模式下，用于切换同级菜单或个位数的减小。 Under measurement mode, used for switching Display item; Under programming mode, used for switching same class menu or ones place reduced.
右键 Right button	测量模式下，用于切换显示项目；编程模式下，用于切换同级菜单或个位数的增加。 Under measurement mode, used for switching Display item; Under programming mode, used for switching same class menu or ones place increase.
回车键 ENTER button	测量模式下，显示电能数据时按该键可查看分时复费率电能（有该功能时）；编程模式下，用于菜单项目的选择确认和参数的修改确认。 Under measurement mode, when Displaying Electric energy data, press This key can look over time sharing multi-rate Electric energy (if any); Programming mode, used for menu item selection confirm and parameter revision confirm.
左键+回车键 Left button + ENTER button	编程模式下，该组合键用于百位数的减小。 Under programming mode, This combined key is used fo hundreds place reduced.
右键+回车键 Right button + ENTER button	编程模式下，该组合键用于百位数的增加。 Under programming mode, This combined key is used for hundreds place increase.

5.3. 操作说明（第1、2、3排数码管分别用LEDA、LEDB、LEDC表示）

5.3.1 查看ACR100E、200E、300E、400E吸收有功电能（用电）、释放有功电能（发电）、感性无功电能、容性无功电能：

在测量状态下，单击左键或右键可以依次切换查看：吸收有功电能EpI←→释放有功电能EPE←→感性无功电能EqL←→容性无功电能EqC。

显示一次侧有功电能EpI/EpE时，Wh灯和k指示灯会点亮，此时低位的电能数据显示在LEDC上，高位数据显示在LEDB上，有功电能的单位为kWh，当电能值达到预定数值时，k灯熄灭，M灯亮，单位转换为MWh。

显示一次侧无功电能EqL/EqC时，varh灯和k灯会点亮，此时低位的电能数据显示在LEDC上，高位数据显示在LEDB上，无功电能的单位为kvarh，当电能值达到预定数值时，k灯熄灭，M灯亮，单位转换为Mvarh。

显示电能时，最高精确到两位小数。

5.3.2 查看ACR110E、210E、310E、410E三相电流和吸收有功电能

在测量状态下，单击左键或右键可以依次切换查看：电流I←→一次侧有功电能EpI。

显示电流I时，I灯会点亮。电流显示的单位通常为A，当一次侧电流达到预定数值时，k灯点亮，显示单位转换为kA。

显示一次侧有功电能EpI时，Ep灯和k灯会点亮，此时低位的电能数据显示在LEDC上，高位数据显示在LEDB上，有功电能的单位为kWh，当电能值达到预定数值时，k灯熄灭，M灯亮，单位转换为MWh。

5.3. Explanation of operation (1, 2, 3 row digitrons is separately presented by LEDA, LEDB, LEDC)

5.3.1 Look over ACR100E、200E、300E、400E capture active Electric energy (power utilization), release active Electric energy (power generation), Inductive reactive Electric energy, capacitive reactive Electric energy:

Under measurement condition, Click left button or right button orderly switching Look over: capture active Electric energy EpI←→release active Electric energy EPE←→Inductive reactive Electric energy EqL←→capacitive reactive Electric energy EqC.

When Displaying primary side active Electric energy EpI/EpE, Wh lamp and k indicator lights, now, the low level Electric energy data Display on the LEDC, the high level data Display on the LEDB, the active Electric energy Unit is kWh, when Electric energy value reach the preset value, k lamp die out, M lamp lights, Unit switch to MWh.

When Displaying primary side reactive Electric energy EqL/EqC, varh lamp and k lamp lights, now, the low level Electric energy data Display on the LEDC, the high level data Display on the LEDB, reactive Electric energy Unit is kvarh, when Electric energy value reach the preset value, k lamp die out, M lamp lights, Unit switch to Mvarh.

When Displaying Electric energy, the highest accuracy should be expressed with two decimal points.

5.3.2 Look over ACR110E、210E、310E、410E three-phase current and capture active Electric energy

Under measurement condition, Click left key or right key can orderly switch Look over: current I←→primary side active Electric energy EpI.

When Displaying current I, I lamp lights. current Display common Unit is A, when primary side current reach to preset value, k indicator lights, Display Unit switch to kA.

When Displaying primary side active Electric energy EpI, Ep lamp and k lamp lights, now, low level Electric energy data Display on the LEDC, high level data Display on the LEDB, active Electric energy Unit is kWh, when Electric energy value reach to preset value, k lamp die out, M lamp lights, Unit switch to MWh.

5.3.3 查看ACR120E、220E、320E、420E电流、电压、功率、电能和频率

在测量状态下，单击左键或右键可以依次切换查看：电压V←→电流I←→功率及功率因数 PQλ←→吸收有功电能EpI←→释放有功电能EPE←→感性无功电能EqL←→容性无功电能EqC←→频率F

显示电压V时，V123灯点亮，在三相四线时，按回车键可切换显示相电压←→线电压。电压单位通常为V，当一次侧电压达到预定数值时，k灯点亮，显示单位转换为kV。

电流显示的单位通常为A，当一次侧电流达到预定数值时，k灯点亮，显示单位转换为kA。

有功功率显示单位为W，无功功率显示单位为var，当功率值达到预定数值时，k灯点亮，显示单位转换为kW或者kvar；当功率值达到预定数值时，k灯熄灭、M灯点亮，显示单位转换为MW或者Mvar。有功功率显示在LEDA上，无功功率显示在LEDB上，功率因素显示在LEDC上。

显示一次侧有功电能EpI/EpE时，Wh灯和k指示灯点亮，此时低位的电能数据显示在LEDC上，高位数据显示在LEDB上，有功电能显示的单位为kWh，当电能值达到预定数值时，k灯熄灭，M灯亮，单位转换为MWh。

显示一次侧无功电能EqL/EqC时，varh灯和k灯点亮，此时低位的电能数据显示在LEDC上，高位数据显示在LEDB上，无功电能显示的单位固定为kvarh，当电能值达到预定数值时，k灯熄灭、M灯亮，单位转换为Mvarh。

显示频率F时，“F”显示在LEDA上，频率值显示在LEDB上，频率单位“Hz”显示在LEDC上。

面板上左边三个灯为功率负号指示灯，当任一负号灯点亮时表明该排显示值为负值；否则为正。

5.3.3 Look over ACR120E、220E、320E、420E current, voltage, power, Electric energy and frequency

Under measurement condition, Click left key or right key can orderly switch Look over: voltage V←→current I←→power and power factor PQλ←→capture active Electric energy EpI←→release active Electric energy EPE←→Inductive reactive Electric energy EqL←→capacitive reactive Electric energy EqC←→frequency F

When Displaying voltage V, V123 lamp lights, under three-phase four wire condition, press ENTER button can switch Display phase voltage←→line voltage. Voltage Unit is usually V, when primary side voltage reach to preset value, k indicator lights, Display Unit switch to kV.

current Display Unit is usually A, when primary side current reach to preset value, k lamp lights, Display Unit switch to kA.

active power Display Unit is W, reactive power Display Unit is var, when power value reach to preset value, k lamp lights, Display Unit switch to kW or kvar; when power value reach to preset value, k lamp die out, M lamp lights, Display Unit switch to MW or Mvar. active power Display on the LEDA, reactive power Display on the LEDB, power factor Display on the LEDC.

When Displaying primary side active Electric energy EpI/EpE, Wh lamp and k indicator lights, now, low level Electric energy data Display on the LEDC, high level data Display on the LEDB, active Electric energy Display Unit is kWh, when Electric energy value reach to preset value, k lamp die out, M lamp lights, Unit switch to MWh.

When Displaying primary side reactive Electric energy EqL/EqC, varh lamp and k lamp lights, now, low level Electric energy data Display on the LEDC, high level data Display on the LEDB, reactive Electric energy Display Unit specified as kvarh, when Electric energy value reach to preset value, k lamp die out, M lamp lights, Unit switch to Mvarh.

When Displaying frequency F, "F" Display on the LEDA, frequency value Display on the LEDB, frequency Unit "Hz" Display on the LEDC.

On the faceplate top-left, three lamps as power minus sign indicator, if any of minus sign indicators lights, the Display value of this row is negative value; otherwise, it is positive value.

5.3.4 查看ACR120EL、ACR220EL、ACR320EL电
流、电压、功率、电能和频率

ACR120EL、ACR220EL、ACR320EL显示二次
侧电能时，电能的低位数据显示在LEDC上，高位数
据显示在LEDB上，有功电能单位kWh，无功电能单
位kvarh。

查看流程见下图：

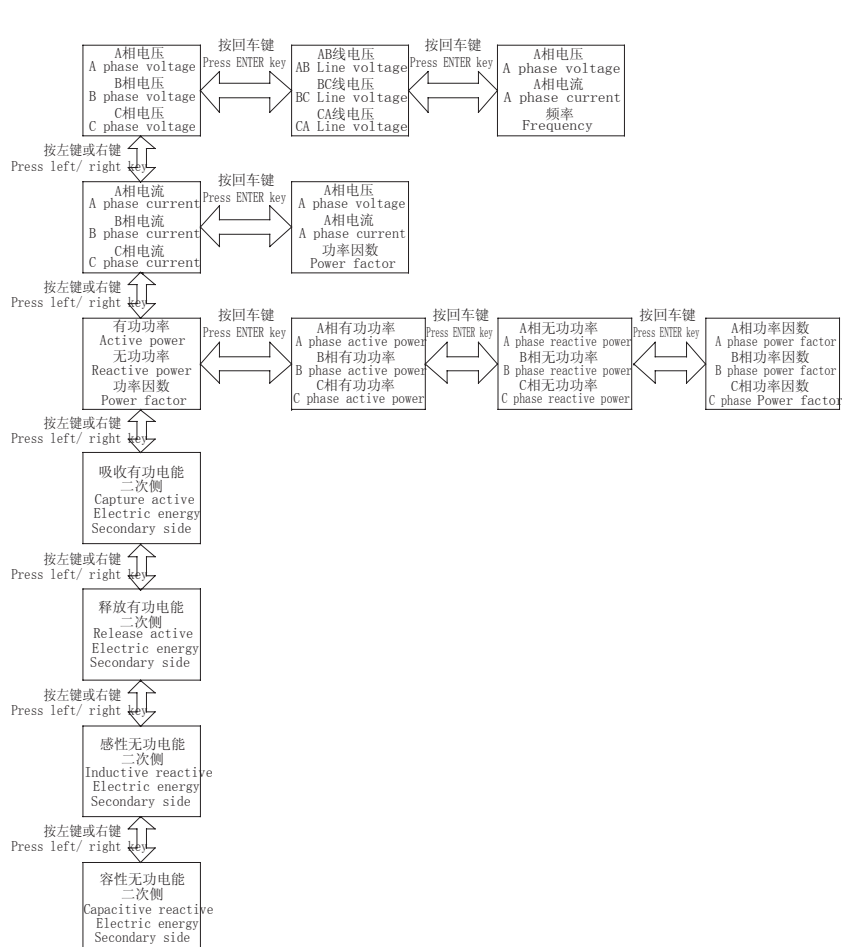

5.3.4、Look over ACR120EL、ACR220EL、
ACR320EL current, voltage, power, Electric energy
and frequency

When ACR120EL、ACR220EL、ACR320EL
Displaying secondary side Electric energy, Electric
energy low level data Display on the LEDC, high
level data Display on the LEDB, active Electric
energy Unit is kWh, reactive Electric energy Unit is
kvarh.

For Look over flow, please see below diagram:

5.3.5 ACR120EFL、ACR220EFL、ACR320EFL查看
流程图

ACR120EL、ACR220EL、ACR320EL显示二次
侧电能时，电能的低位数据显示在LEDC上，高位数
据显示在LEDB上有有功电能单位kWh，无功电能单
位kvarh。

5.3.5、ACR120EFL、ACR220EFL、ACR320EFL
Look over flow chart

ACR120EL、ACR220EL、ACR320EL Display
secondary side Electric energy, Electric energy low
level data Display on the LEDC, high level data
Display on the LEDB active Electric energy Unitk is
Wh, reactive Electric energy Unit is kvarh.

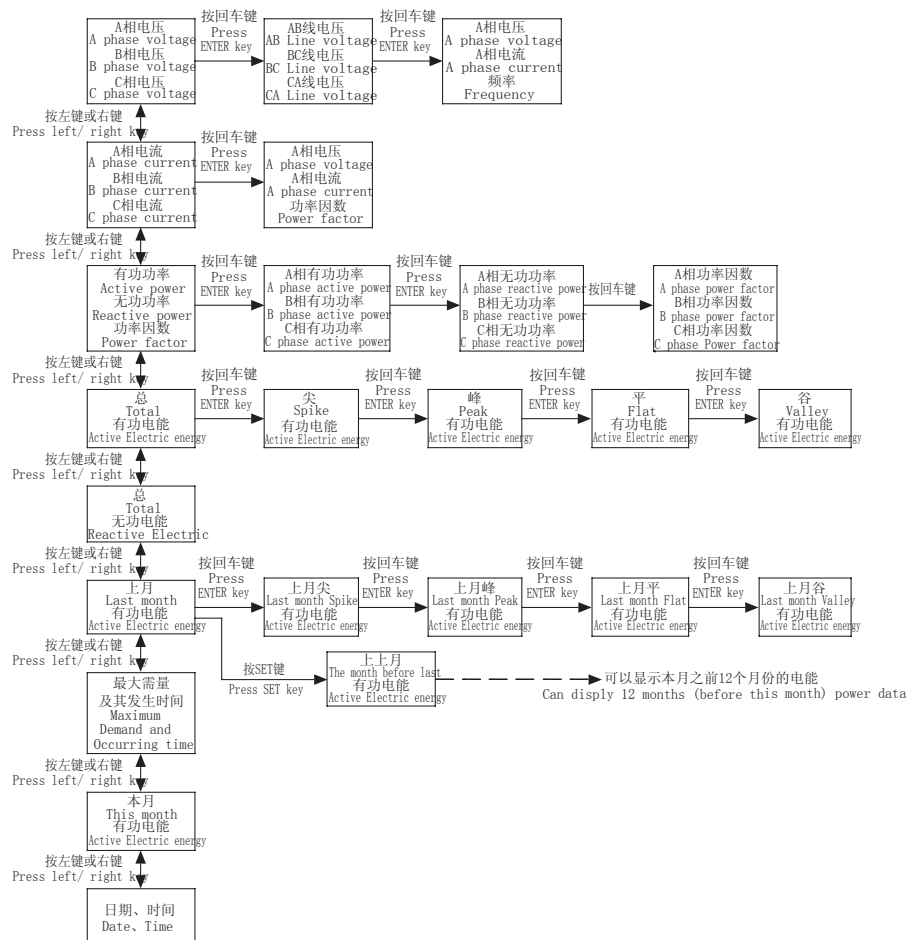

5.4 编程菜单

5.4 Programming menu

5.4.1 仪表通用编程菜单

5.4.1 Meters general Programming menu

第一级菜单 First menu	第二级菜单 Second menu	第三级菜单 Tertiary menu	说明 Description
545	dISP	1-6	开机显示画面选择 Power-on display picture selection
	Code	0-9999	密码设置(初始密码0001) Password setting (Initial password 0001)
	CrE		按回车键, 电能清零 Press ENTER key, Electric energy clear
In	Line InU	3P3L、3P4L	接线方式(三相三线、三相四线) Connection mode (Three-phase-three-wire, Three-phase-four-wire)
		100、400	输入电压范围 Input voltage range
	InI	1、5	输入电流范围 Input current range
	InPt	0-9999	电压倍数 Voltage Multiple
	InCt	0-9999	电流倍数 Current Multiple
bu5	Addr	1-247	通讯地址 Communication address
	baud	4800、9600、19200、38400	通讯波特率 Communication baud rate
tr.1	001-026 101-126	0-9999	第一路变送输出(详见5.4.2) First channel transforming output(for details, see 5.4.2)
Tr.2~tr.4	同上 Ditto	同上 Ditto	第二路到第四路变送输出(详见5.4.2) Second channel to fourth channel transforming output(for details, see 5.4.2)

5.4.2 LCD显示仪表的背光控制菜单

5.4.2. Backlight control menu of LCD Display meters

第一级菜单 First menu	第二级菜单 Second menu	第三级菜单 Tertiary menu	说明 Description
545	bLcd	0-255	设置为0时, 背光常亮; 设置为1-255时, 背光在亮1-255秒后熄灭 Setting as 0, backlight lights; Setting as 1-255, backlight after lights for 1-255 second, go out

5.4.3 开关量输出增加的菜单

5.4.3. Menu for increasing switching output

ACR仪表开关量输出采用继电器输出, 有两种控制方式: 1、电平方式(继电器触点常开或常闭); 2、脉冲方式(继电器触点闭合一段时间后断开, 闭合时间由PL.do控制)。

ACR meters switching output adopt relay output, with two control modes: 1, electrical level mode (contact of relay as NO or NC); 2, pulse mode(contact of relay is closed for specified time then breaking, the closing time is controlled by PL.do).

第一级菜单 First menu	第二级菜单 Second menu	第三级菜单 Tertiary menu	说明 Description
545	PL.do	0-255	设置为0时, 继电器为电平控制方式; 设置为1-255时, 继电器为脉冲控制方式, 单位0.01秒 Setting as 0, relay adopt level control mode; Setting as 1-255, relay adopt pulse control mode, unit as 0.01 second

5.4.4 复费率仪表增加的菜单

复费率电能一天最多可分成8个时段、4种费率来完成电能的分时计量。

5.4.4 Menu for increasing multi-tariff meters

Multi-rate Electric energy may be divided into:8 time segment/24 hours, the Electric energy time sharing metering adopt 4-rate mode.

第一级菜单 First menu	第二级菜单 Second menu	第三级菜单 Tertiary menu	说明 Description
DATE	年 Year	月、日 Month, Day	设置当前时间 Setting current time
TIME	时 Hour	分、秒 Minute, Second	
rt-1	4	0600	在24:00~06:00时间段中, 费率为4-谷 In the 24:00~06:00 period of time, the rate as 4- Valley
rt-2	3	0800	在06:00~08:00时间段中, 费率为3-平 In the 06:00~08:00 period of time, the rate as 3- Flat
rt-3	2	1000	在08:00~10:00时间段中, 费率为2-峰 In the 08:00~10:00 period of time, the rate as 2- Peak
rt-4	1	1200	在10:00~12:00时间段中, 费率为1-尖 In the 10:00~12:00 period of time, the rate as 1- Spike
rt-5	2	1400	在12:00~14:00时间段中, 费率为2-峰 In the 12:00~14:00 period of time, the rate as 2- Peak
rt-6	1	1600	在14:00~16:00时间段中, 费率为1-尖 In the 14:00~16:00 period of time, the rate as 1- Spike
rt-7	2	2200	在16:00~22:00时间段中, 费率为2-峰 In the 16:00~22:00 period of time, the rate as 2- Peak
rt-8	3	2400	在22:00~24:00时间段中, 费率为3-平 In the 22:00~24:00 period of time, the rate as 3- Flat

5.5 编程示例

编程示例以流程图的形式介绍改变编程菜单中的某些选项, 如电流倍数、变送设置等。

注: 在设置或选择完成后, 需按回车键进行确认, 确认完成后连续点按SET键直到出现SAVE/YES页面, 此时必须按回车键确认, 否则设置无效。

5.5. Programming example

The programming example use flow chart to introduce how to change some options of programming menu such as current times, transducer setting etc.

Note: After completing setting or selecting, press ENTER button to confirm, after confirming, pressing SET key until SAVE/YES page appear, now, the ENTER button must be pressed to confirm, otherwise, the setting is invalid.

5.5.1 如何修改电流倍数

5.5.1 How to revise the current times

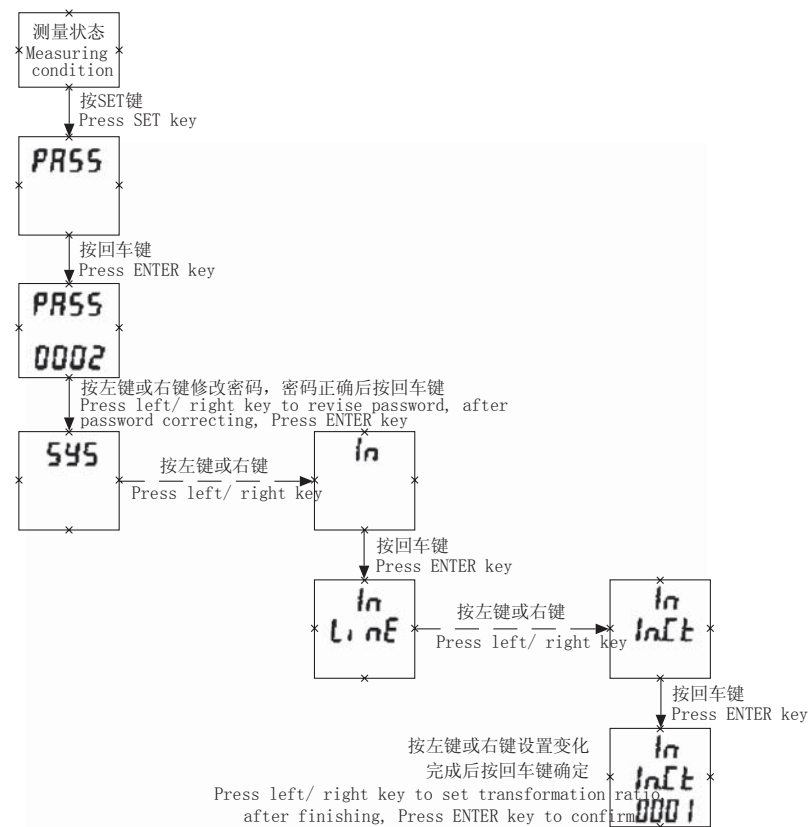

5.5.2 如何修改变送设置

模拟变送输出可选择将电网中常见的26个电量(UA、UB、UC、UAB、UBC、UCA、IA、IB、IC、PA、PB、PC、P总、QA、QB、QC、Q总、SA、SB、SC、S总、PFA、PFB、PFC、PF、F) 隔离变送输出为0~20mA或4~20mA的直流信号。

5.5.2 How to revise transmitting setting

Analog transmitting output can select any of 26 electric parameters from grid (UA、UB、UC、UAB、UBC、UCA、IA、IB、IC、PA、PB、PC、P total、QA、QB、QC、Q total、SA、SB、SC、S total、PFA、PFB、PFC、PF、F) and isolate transmitting output as DC signal of 0~20mA or 4~20mA.

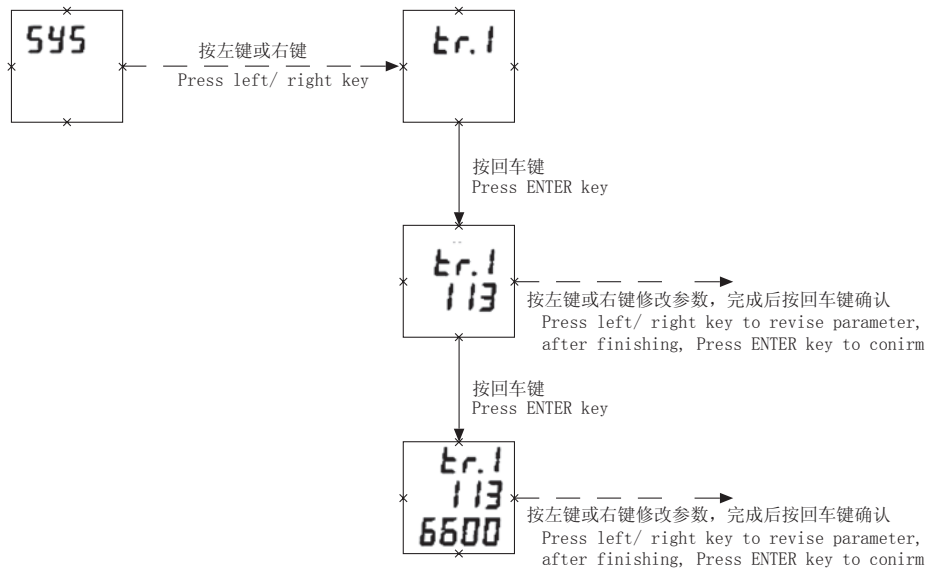

tr.1

第一路变送
First channel transmitting

113

左起第一位为变送选择, 如果是0~20mA输出, 则为0, 如果是4~20mA输出, 则为1; 第二、三位为变送量代号, 对应关系见下表, 这里13表示有功功率P总

The first bit from left is the transmitting selection, as 0~20mA Output, it is 0, as 4~20mA Output, it is 1; the second bit, third bit as transmitting code, its Correspondent relation see table, here 13 indicate active power P total

01	02	03	04	05	06	07	08	09	10	11	12	13
UA	UB	UC	UAB	UBC	UCA	IA	IB	IC	PA	PB	PC	P总
14	15	16	17	18	19	20	21	22	23	24	25	26
QA	QB	QC	Q总	SA	SB	SC	S总	PFA	PFB	PFC	PF总	F

6600

20mA输出与电量的显示值相对应, 取最高四位整数(小数点忽略)不足补0。如输入为220V, 100A/5A, 三相四线, 则100% P总为220V×100A×3=66kW, 该值取6600, 若三相三线, 则220kV×100A×√3=38.10kW, 该值取3810;

20mA Output is corresponding to electric parameter Display value, take the highest 4 bit integer such as: Input as 220V, 100A/5A, three-phase four wire, then 100% P total as 220V×100A×3=66kW, taking 6600, for three-phase three wire, then 220kV×100A×√3=38.10kW, taking 3810;

6.1.2 信息帧格式

6.1.2 Information frame format

地址码 Address code	功能码 Function code	数据区 Data area	CRC校验码 CRCcheck code
1字节 1 byte	1字节 1 byte	n字节 n byte	2字节 2 byte

地址码：地址码在帧的开始部分，由一个字节（8位二进制码）组成，十进制为0~255，在ACR仪表中只使用1~247，其它地址保留。这些位标明了用户指定的终端设备的地址，该设备将接收来自与之相连的主机数据。每个终端设备的地址必须是唯一的，仅仅被寻址到的终端会响应包含了该地址的查询。当终端发送回一个响应，响应中的从机地址数据便告诉了主机哪台终端正与之进行通信。

Address code: address code is located at beginning of frame, composed of one byte(8 bit binary system code), decimal system is 0~255, in the ACR meters, just 1~247 is used, other address is Reserved. these bits indicate terminal device address specified by users, this device will receive the connecting host computer data. Every terminal devic has its only one address, only the addressing terminal is responding enquiry including this address. When terminal is Transmitting one responding, the responding slave address data tell host computer that which terminal is communicating with it.

功能码：功能码告诉了被寻址到的终端执行何种功能。下表列出了该系列仪表用到的功能码，以及它们的意义和功能。

Function code: function code tell the addressed terminal to execute what function. Below table list: function code used in this Series meters, and their meaning and function.

功能 Function	定义 Definition	操作 Operation
03H/04H	读数据寄存器 Read data register	获得一个或多个寄存器的当前二进制值 Obtain current binary system value of one or multiple register
10H	预置多寄存器 Preset multi-register	设定二进制值到一系列多寄存器中 Set binary system value into a series o multi-registe

数据区：数据区包含了终端执行特定功能所需要的数据或者终端响应查询时采集到的数据。这些数据的内容可能是数值、参考地址或者设置值。例如：功能码告诉终端读取一个寄存器，数据区则需要指明从哪个寄存器开始及读取多少个数据，内嵌的地址和数据依照类型和从机之间的不同内容而有所不同。

Data area: data area is including the data needed by terminal for executing specific function, or the collected data when terminal is responding enquiry . Content of these data may be value, reference address or setting value. For example: The function code tell terminal to Read one register, the data area need to specify the starting register and Read how many data, the built-in address and data have different content depending on type and slave computer.

CRC校验码：错误校验（CRC）域占用两个字节，包含了一个16位的二进制值。CRC值由传输设备计算出来，然后附加到数据帧上，接收设备在接收数据时重新计算CRC值，然后与接收到的CRC域中的值进行比较，如果这两个值不相等，就发生了错误。

CRC check code: Error check (CRC) domain occupy 2 byte, including one 16 bit binary system value. CRC value is calculated by transmission device, then attached to the data frame, the receiving device, while receiving, it calculates the CRC value again, then comparing it with the receiving CRC domain value, if these two values is not equal, it shows a error occurs.

生成一个CRC的流程为：

- 1、预置一个16位寄存器为0FFFFH(全1)，称之为CRC寄存器。
- 2、把数据帧中的第一个字节的8位与CRC寄存器中的低字节进行异或运算，结果存回CRC寄存器。
- 3、将CRC寄存器向右移一位，最高位填以0，最低位移出并检测。
- 4、如果最低位为0，重复第三步(下一次移位)；如果最低位为1，将CRC寄存器与一个预设的固定值(0A001H)进行异或运算。
- 5、重复第三步和第四步直到8次移位。这样处理完了一个完整的八位。
- 6、重复第2步到第5步来处理下一个八位，直到所有的字节处理结束。
- 7、最终CRC寄存器的值就是CRC的值。

此外还有一种利用预设的表格计算CRC的方法，它的主要特点是计算速度快，但是表格需要较大的存储空间，该方法此处不再赘述，请参阅相关资料。

Flow for forming one CRC:

- 1、Preset one 16 bit register as 0FFFFH (All-1), called as CRC register.
- 2、8 bit of data frame first byte and low byte of CRC register carry out exclusive or operation, then save its result back to CRC register.
- 3、Right shift CRC register for one bit, the most significant bit is filled with 0, the least significant is shifted out and tested.
- 4、If the least significant bit is 0, Repeat the third step (next shift); If the least significant bit is 1, CRC register and preset fixed value specified (0A001H) carry out exclusive or operation.
- 5、Repeat the third step and the fourth step until shift for 8 times, the complete 8 bit is done.
- 6、Repeat the second step to the fifth step to treat next 8 bit until all the byte is treated.
- 7、The CRC register final value is CRC value.

Besides, there is another CRC calculation method by preset table, its main feature is fast calculating speed, but large saving space is needed, please refer to related data.

6.2 功能码简介

6.2.1 功能码03H或04H: 读寄存器

此功能允许用户获得设备采集与记录的数据及系统参数。主机一次请求的数据个数没有限制，但不能超出定义的地址范围。

下面的例子是从01号从机读3个采集到的基本数据(数据帧中每个地址占用2个字节) UAB、UBC、UCA，其中UAB的地址为0028H，UBC的地址为0029H，UCA的地址为002AH。

主机发送 Master transmitting		发送信息 Transmitting information
地址码 Address code		01H
功能码 Function code		03H
起始地址 Initial address	高字节 High byte	00H
	低字节 Low byte	28H
寄存器数量 Register quantity	高字节 High byte	00H
	低字节 Low byte	03H
CRC校验码 CRC check code	高字节 High byte	85H
	低字节 Low byte	C3H

6.2 Briefing for function code

6.2.1 function code 03H or 04H: Read register

This function permits user to Obtain data and system parameters collected and recorded by the device. The data number requested by host computer for each time have no limit, but does not exceed the address range specified by Definition .

The following example is No. 01 slave computer Read 3 collected basic data (data frame every address occupy 2 byte)UAB、UBC、UCA、in it, UAB address is 0028H, UBC address is 0029H, UCA address is 002AH.

从机返回 Slave return		返回信息 Return information
地址码 Address code		01H
功能码 Function code		03H
字节数 Byte quantity		06H
寄存器数据 Register data	高字节 High byte	不定值 Under-range
	低字节 Low byte	不定值 Under-range
寄存器数据 Register data	高字节 High byte	不定值 Under-range
	低字节 Low byte	不定值 Under-range
寄存器数据 Register data	高字节 High byte	不定值 Under-range
	低字节 Low byte	不定值 Under-range
CRC校验码 CRC check code	高字节 High byte	21H
	低字节 Low byte	75H

6.2.2 功能码10H: 写寄存器

功能码10H允许用户改变多个寄存器的内容，该仪表中系统参数、开关量输出状态等可用此功能号写入。主机一次最多可以写入16个(32字节)数据。

下面的例子是预置地址为01的仪表输出开关量Do1。开关量输入/输出状态指示寄存器地址为0022H，第9-12位对应DI1-DI4，第13-14位分别对应D01-D02。

主机发送 Master transmitting		发送信息 Transmitting information
地址码 Address code		01H
功能码 Function code		10H
起始地址 Initial address	高字节 High byte	00H
	低字节 Low byte	22H
寄存器数量 Register quantity	高字节 High byte	00H
	低字节 Low byte	01H
字节数 Byte quantity		02H
0022H 待写入数据 0022H Data to be read-in	高字节 High byte	10H
	低字节 Low byte	00H
CRC校验码 CRC check code	高字节 High byte	ADH
	低字节 Low byte	12H

6.2.2 Function code 10H: read-in register

Function code 10H permit user to change content of multiple registers, System parameters, switching output condition etc. may be written by using the function. maximum once read-in data for the host computer is 16 (32 byte) data .

Below example shows: meters Output switching Do1 with Preset address 01. switching input/Output condition indicating register address 0022H, 9th-12th bit corresponding to DI1-DI4, 13th-14th bit corresponding to D01-D02 respectively.

从机返回 Slave return		返回信息 Return information
地址码 Address code		01H
功能码 Function code		10H
起始地址 Initial address	高字节 High byte	00H
	低字节 Low byte	22H
寄存器数量 Register quantity	高字节 High byte	00H
	低字节 Low byte	01H
CRC校验码 CRC check code	高字节 High byte	A1H
	低字节 Low byte	C3H

6.2.3 功能码x8H: 读电能数据

ACR120EFL、ACR220EFL、ACR320EFL网络电力仪表将本月之前一年的电能数据存储在专用芯片中，用户可通过x8H(x为所要查询的月份，注：08H为电能清零命令)命令查询相应月份的电能。对于查询召唤月电能请求的正常响应是从机地址、功能号、年、月、总、尖、峰、平、谷电能(电能数据占一个字)、CRC校验码。例：假设当前月为07年12月，要查询07年11月份的复费率电能，如下表：

主机发送 Master transmitting		发送信息 Transmitting information
地址码 Address code		01H
功能码 Function code		B8H
CRC校验码 CRC check code	高字节 High byte	00H
	低字节 Low byte	52H

6.2.3 Function code x8H: Read Electric energy data

ACR120EFL、ACR220EFL、ACR320EFL Network power meters save one year(before this month) Electric energy data into the special chip, user can adopt x8H command(x is the enquiring month, Note: 08His the Electric energy clear command)to enquire Electric energy of target month. The normal answer for enquiring Electric energy of target month: slave address, function number, year, month, total, spike, peak, flat, valley Electric energy(Electric energy data occupy one character), CRC check code. Example:Suppose the current month is 07/12, to enquire 07/11 multi-rate Electric energy, the result is shown as below table:

从机返回 Slave return	返回信息 Return information	
地址码 Address code	01H	
功能码 Function code	B8H	
年 Year	07H	
月 Month	0BH	
总有功电能 Total active Electric energy	00H	
尖有功电能 Spike active Electric energy	00H	
峰有功电能 Peak active Electric energy	00H	
平有功电能 Flat active Electric energy	00H	
谷有功电能 Valley active Electric energy	00H	
CRC校验码 CRC check code	高字节 High byte	F3H
	低字节 Low byte	2AH

6.3 通讯应用细节

ACR仪表在设计时对通讯地址表进行了统一规划，用户根据下面的介绍可以方便地实现遥测、遥信、遥控等功能。

6.3.1 开关量输入输出

ACR仪表开关量输入是采用干接点开关信号输入方式，仪表内部配备+5V的工作电源，无须外部供电。当外部接点闭合或断开时，仪表本地显示开关状态，同时可以通过仪表的通讯口实现远程传输功能，即“遥信”功能。

ACR仪表开关量输出为继电器输出，可通过上位机远程控制(遥控有两种方式：1、电平触发；2、脉冲触发)，实现“遥控”功能，也可以根据客户要求实现相应的报警功能(如过流、欠压)。

ACR仪表与开关量输入输出相关的通讯地址为0022H，其与开关量输入输出的对应关系如下：

6.3 Communication application details

When designing, ACR meters make consolidated planning of Communication address table, user can easily implement telemetry, signaling, telecontrol etc. functions based on following introduction.

6.3.1 Switching input Output

ACR meters switching input adopt dry contacts switching signal Input mode, meters built-in +5V operational Power supply, the external power supply is not necessary. When external contacts is closing or opening, meters Display switching condition locally, and through meters Communication port, the long distance transmission function, i.e. "signaling" function is implemented.

ACR meters switching output adopt relay output, by means of

Supervisory computer long distance control (telecontrol with two modes: 1、electrical level trigger; 2、pulse trigger), implement "telecontrol" function, or implement corresponding alarm function(such as over current, under voltage).

ACR meters about switching input Output Communication address is 0022H, the switching input Output corresponding relation is shown as following:

1、对ACR120EK、ACR120E (F) LK、ACR220EK、ACR220E (F) LK:

0022H	16	15	14	13	12	11	10	9	8~1
			D02	D01	DI4	DI3	DI2	DI1	保留 Reserved

2、对ACR320EK、ACR320E (F) LK:

0022H	16	15	14	13	12	11	10	9	8~1
	DI1	DI2	DI3	DI4	D01	D02	D03	D04	保留 Reserved

3、对ACR320EK (SDI) 、ACR420EK:

0022H	16	15	14	13	12	11	10	9	8	7	6	5	4-1
	DI1	DI2	DI3	DI4	DI5	DI6	DI7	DI8	D01	D02	D03	D04	保留 Reserved

6.3.2 电力参数与电能

该系列测量值用Modbus-RTU 通讯规约的03号命令读出，通讯值与实际值之间的对应关系如下：(约定Val_t为通讯读出值，Val_s为实际值)

1、相电压UA、UB、UC、线电压UAB、UBC、UCA:

$Val_s = Val_t \times 10^4$ (DPT-4)，单位伏V，DPT从0023H高字节读出。

2、电流IA、IB、IC:

$Val_s = Val_t \times 10^4$ (DCT-4)，单位安培A，DCT从0023H低字节读出。

3、功率PA、PB、PC、P总、QA、QB、QC、Q总:

$Val_s = Val_t \times 10^4$ (DPQ-4)，有功功率单位瓦W，无功功率单位乏var，DPQ从0024H高字节读出，有功功率和无功功率的单位从0024H低字节(从高到低位依次为Q、Qc、Qb、Qa、P、Pc、Pb、Pc) 读出。

4、功率因数PFA、PFB、PFC、PFS:

$Val_s = Val_t / 1000$ ，无单位

5、频率:

$Val_s = Val_t / 100$ ，单位赫兹Hz

6.3.2 Power parameters and Electric energy

This Series measurement value is read-out by No.3 command of Modbus-RTU Communication protocol, the corresponding relation between the Communication value and actual value are shown as following: (promising Val_tas Communication Read-out value, Val_s as actual value)

1、Phase voltage UA、UB、UC、line voltage UAB、UBC、UCA:

$Val_s = Val_t \times 10^4$ (DPT-4), Unit: V, DPT from 0023H high byte Read-out.

2、current IA、IB、IC:

$Val_s = Val_t \times 10^4$ (DPT-4), Unit: A, DCT from 0023H low byte Read-out.

3、Power PA、PB、PC、P total、QA、QB、QC、Q total:

$Val_s = Val_t \times 10^4$ (DPQ-4), active power Unit: W, reactive power Unit: var, DPQ from 0024H high byte Read-out, active power and reactive power Unit from 0024H low byte (from high to low level order: Q、Qc、Qb、Qa、P、Pc、Pb、Pc) Read-out.

4、Power factor value PFA、PFB、PFC、PFS:

$Val_s = Val_t / 1000$, not to have Unit

5、frequency:

$Val_s = Val_t / 100$, Unit: Hz

6、电能:

对ACR系列网络电力仪表,有以下a、b两种方法读取电能,用户可根据实际情况选用。

a) 分别读地址003FH~0040H(吸收有功电能)、0041H~0042H(释放有功电能)、0043H~0044H(感性无功电能)、0045H~0046H(容性无功电能)二次侧电能、再读PT、CT,按照下面公式计算:

电能通讯读出值Val_t=第一个word×65536+第二个word

电能量一次侧值Val_s=Val_t /1000×PT×CT,有功电能单位千瓦时kWh,无功电能单位千乏时kvarh。其中PT从地址0003H里读出,CT从地址0004H里读出。

注:一般情况下用户读取吸收有功电能

b) 读0047H_004EH里的一次侧电能该值采用浮点变量数据类型。它用符号位表示数的符号,用指数和尾数表示数的大小。仪表采用的数据格式为IEEE754数据格式具有24位精度,尾数的高位始终为“1”,因而不保存,位的分布如下:

1位符号位、8位指数位、23位尾数,符号位是最高位,尾数为最低的23位。

具体举例如下:

读出数(如03FH 040H, 2word,由高至低排列 共4byte,32bit,):

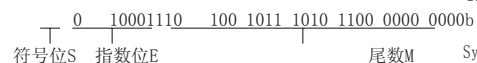

符号位S=0,“1”为负,“0”为正;

计算指数E=10001110,化为10进制数142;

计算尾数M=100 1011 1010 1100 0000 0000,

化为10进制数4959232。

计算公式:一次侧电量

$$=(-1)^S \times 2^{(E-127)} \times \left(1 + \frac{M}{2^{23}}\right)$$

上例计算结果为:
calculated result of above example as:

$$(-1)^0 \times 2^{(142-127)} \times \left(1 + \frac{4959232}{2^{23}}\right)$$

=52140 Wh=52.14kWh

6、Electric energy:

For ACR Series Network power meters, there are two methods of a, b, to Read Electric energy, user can select one based on actual condition.

b) Respectively Read address 003FH~0040H(capture active Electric energy), 0041H~0042H(release active Electric energy), 0043H~0044H(Inductive reactive Electric energy), 0045H~0046H(capacitive reactive Electric energy) secondary side Electric energy, Read PT、CT again, calculating as per following formula:

Electric energy Communication Read-out value Val_t=First word×65536 + second word

Electric energy primary side value Val_s=Val_t / 1000×PT×CT, active Electric energy Unit: kWh, reactive Electric energy Unit: kvarh. Thereinto PT Read-out from address 0003H,CT Read-out from address 0004H.

Note: Under general run of things, user Read capture active Electric energy

b) Read 0047H~004EH primary side Electric energy value adopt floating-point variable data type. It use symbol bit show symbol of number, size of number is indicated by exponent and mantissa. The meters adopting data format is IEEE754 data format with 24 bit Precision, mantissa high level is always “1”,so, need not saving, bit distribution is shown as following:

1 bit-symbol bit, 8 bit-exponent bit, 23 bit-mantissa, symbol bit is the most significant bit, and mantissa is the lowest 23 bit.

The concrete example is shown as following:

Read-out number(such as 03FH 040H, 2word, from high to low arrange total 4 byte,32 bit,):

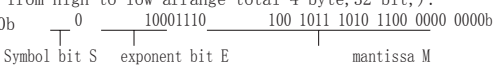

symbol bit S=0, “1” as negative, “0” as positive; calculating exponent mantissa E=10001110, change into decimal system as 142;

calculating mantissa M=100 1011 1010 1100 0000 0000, change into decimal system as 4959232.

computing formula: primary side quantity of electricity

6.4 通讯地址表

6.4 Communication address table

地址 Address	参数 Parameter	读写属性 Read or write	数值范围 Value range	数据类型 Data type
0000H	保护密码 Protective password	R/W	0001-9999	Word
0001H 高字节 0001H high byte	通讯地址 Communication address	R/W	0001-0247	Word
0001H 低字节 0001H low byte	通讯波特率 Communication baud rate	R/W	0-3: 38400、19200、9600、4800bps	
0002H	控制字 Control word	R/W	第8位—接线方式(0-三相四线、1-三相三线) 第7位—输入电压范围(0-400V、1-100V) 第2位—输入电流范围(0-5A、1-1A) 8th bit-Connection mode (0-three-phase four wire, 1-three-phase three wire) 7th bit-Input voltage range (0-400V, 1-100V) Second bit-Input current range(0-5A, 1-1A)	Word
0003H	PT变比 PT transformation ratio	R/W	1-9999	Word
0004H	CT变比 CT transformation ratio	R/W	1-9999	Word
0005H~000AH	tr.1~tr.4四路变送 参数设置 Tr.1~tr.4 4 channels transmitting Parameter setting	R/W	每一路占用三个字节(第一个字节为变送输出选择、 第二第三两个字节为输出满度对应值) Each channels occupy 3 byte (first byte as transmitting output selection, 2nd, third byte as Output full range corresponding to value)	Word
000BH~0010H	保留 Reserved			Word
0011H 高字节 0011H high byte	背光控制 Backlight control	R/W	仅适用LCD显示仪表0为常亮 Only applied to LCD Display meters 0= lights	Word
0011H 低字节 0011H low byte	继电器输出脉冲宽度控制 Relay output pulse width control	R/W	仅适用带开关量输出仪表 Only applied to switching output meters	
0012H~001DH	rt-1~rt-8八个时段 参数设置 Rt-1 rt-8 8-period of time Parameter setting	R/W	每个时段占用三个字节 Each-period of time occupy 3 byte	Word

001EH~001FH	日期时间设置 Data time setting	R/W	年、月、日、时、分、秒 Year, month, day, hour, minute, secon	Word
0021H 高字节 0021H high byte	自动抄表日 Automatic meter reading date	R/W	月、日 Month, day	Word
0021H 低字节 0021H low byte	当前时间费率 Current time Rate	R/W	1-尖、2-峰、3-平、4-谷 1-spike, 2-peak, 3-flat, 4-valle	
0022H	开关量输入输出状态 Switching Input output condition	R/W	见6.3.1 See 6.3.1	Word
0023H 高字节 0023H high byte	小数点U(DPT) Decimal point U(DPT)	R	3~7	Word
0023H 低字节 0023H low byte	小数点I(DCT) Decimal point I(DCT)	R	1~5	
0024H 高字节 0024H high byte	小数点PQ(DPQ) Decimal point PQ(DPQ)	R	4~10	Word
0024H 低字节 0024H low byte	符号PQ Symbol PQ	R	高位—低位: Q、Qc、Qb、Qa、P、Pc、Pb、Pa; 0为正, 1为负 High level-low level: Q、Qc、Qb、Qa、P、Pc、Pb、Pa; 0 as positive, 1 as negative	
0025H	相电压UA Phase voltage UA	R	0-9999	Word
0026H	相电压UB Phase voltage UB	R	0-9999	Word
0027H	相电压UC Phase voltage UC	R	0-9999	Word
0028H	线电压UAB Line voltage UAB	R	0-9999	Word
0029H	线电压UBC Line voltage UBC	R	0-9999	Word
002AH	线电压UAC Line voltage UAC	R	0-9999	Word
002BH	IA	R	0-9999	Word
002CH	IB	R	0-9999	Word

002DH	IC	R	0-9999	Word
002EH	PA	R	0-9999	Word
002FH	PB	R	0-9999	Word
0030H	PC	R	0-9999	Word
0031H	P总 P total	R	0-9999	Word
0032H	QA	R	0-9999	Word
0033H	QB	R	0-9999	Word
0034H	QC	R	0-9999	Word
0035H	Q总 P total	R	0-9999	Word
0036H	PFA	R	0-9999	Word
0037H	PFB	R	0-9999	Word
0038H	PFC	R	0-9999	Word
0039H	PF总 PF total	R	0-9999	Word
003AH	SA	R	0-9999	Word
003BH	SB	R	0-9999	Word
003CH	SC	R	0-9999	Word
003DH	S总 S total	R	0-9999	Word
003EH	频率FR Frequency FR	R	4500-6500	Word

以下为电能地址表 Electric energy address table				
003FH~0040H	吸收有功电能二次侧 Capture active Electric energy secondary side	R/W	0-999999999	Dword
0041H~0042H	释放有功电能二次侧 Release active Electric energy secondary side	R/W	0-999999999	Dword
0043H~0044H	感性无功电能二次侧 Inductive reactive Electric energy secondary side	R/W	0-999999999	Dword
0045H~0046H	容性无功电能二次侧 Capacitive reactive Electric energy secondary side	R/W	0-999999999	Dword
0047H~0048H	吸收有功电能一次侧 Capture active Electric energy primary side	R		Fword
0049H~004AH	释放有功电能一次侧 Release active Electric energy primary side	R		Fword
004BH~004CH	感性无功电能一次侧 Inductive reactive Electric energy primary side	R		Fword
004DH~004EH	容性无功电能一次侧 Capacitive reactive Electric energy primary side	R		Fword

以下部分为ACRxxxEFL带复费率电能计量的补充地址表，所有电能均为二次侧电能
Follows are ACRxxxEFL complementary address table fitted with multi-rate electric energy measurement, all Electric energy are secondary side Electric energy.

004FH	最大需量 Maximum demand	R	0-9999	Word
0050H~0051H	最大需量发生时间 Maximum demand occur time	R	月、日、时、分 Month, day, hour, minute	Dword
0052H~0053H	总有功电能二次侧 Total active Electric energy secondary side	R/W	0-999999999	Dword
0054H~0055H	总尖有功电能二次侧 Total spike active Electric energy secondary side	R/W	0-999999999	Dword
0056H~0057H	总峰有功电能二次侧 Total peak active Electric energy secondary side	R/W	0-999999999	Dword
0058H~0059H	总平有功电能二次侧 Total flat active Electric energy secondary side	R/W	0-999999999	Dword
005AH~005BH	总谷有功电能二次侧 Total valley active Electric energy secondary side	R/W	0-999999999	Dword
005CH	所要查询电能的时间 Enquiring Electric energy time	R	年、月 Year, month	Dword

005DH~005EH	所查询月总有功电能 Enquiring month total active Electric energy	R/W	0-999999999	Dword
005FH~0060H	所查询月尖有功电能 Enquiring month spike active Electric energy	R/W	0-999999999	Dword
0061H~0062H	所查询月峰有功电能 Enquiring month peak active Electric energy	R/W	0-999999999	Dword
0063H~0064H	所查询月平有功电能 Enquiring month flat active Electric energy	R/W	0-999999999	Dword
0065H~0066H	所查询月谷有功电能 Enquiring month valley active Electric energy	R/W	0-999999999	Dword
0067H	当前时间 Current time	R	年、月 year, month	Dword
0068H~0069H	当前月总有功电能 Current month total active Electric energy	R/W	0-999999999	Dword
006AH~006BH	当前月尖有功电能 Current month spike active Electric energy	R/W	0-999999999	Dword
006CH~006DH	当前月峰有功电能 Current month peak active Electric energy	R/W	0-999999999	Dword
006EH~006FH	当前月平有功电能 Current month flat active Electric energy	R/W	0-999999999	Dword
0070H~0071H	当前月谷有功电能 Current month valley active Electric energy	R/W	0-999999999	Dword